



**DR. BABASAHEB AMBEDKAR  
OPEN UNIVERSITY**

# DCA

## DIPLOMA IN COMPUTER APPLICATION



**DCAR- 102**

**Operating System & Software Installation**

# **OPERATING SYSTEM AND SOFTWARE INSTALLATION**



**DR. BABASAHEB AMBEDKAR OPEN UNIVERSITY  
AHMEDABAD**

## **Editorial Panel**

**Author : Dr. Himanshu Patel**  
**Assistant Professor,**  
**School of Computer Science,**  
**Dr. Babasaheb Ambedkar Open University,**  
**Ahmedabad**

**Reviewer : Prof. (Dr.) Nilesh Modi**  
**Professor and Director,**  
**School of Computer Science,**  
**Dr. Babasaheb Ambedkar Open University,**  
**Ahmedabad**

**Language Editor : Dr. Vasant K. Joshi**  
**Associate Professor,**  
**G. B. Shah Commerce College,**  
**Ahmedabad.**

**ISBN 978-81-943679-7-0**

**Edition : 2020**

**Copyright © 2020 Knowledge Management and Research Organisation.**

All rights reserved. No part of this book may be reproduced, transmitted or utilized in any form or by a means, electronic or mechanical, including photocopying, recording or by any information storage or retrieval system without written permission from us.

## **Acknowledgment**

The content in this book is modifications based on work created and shared by the African Virtual University for the book titled Introduction to Operating

Systems and used according to terms described in the Creative Commons 2.5 Attribution License.



## **ROLE OF SELF-INSTRUCTIONAL MATERIAL IN DISTANCE LEARNING**

The need to plan effective instruction is imperative for a successful distance teaching repertoire. This is due to the fact that the instructional designer, the tutor, the author (s) and the student are often separated by distance and may never meet in person. This is an increasingly common scenario in distance education instruction. As much as possible, teaching by distance should stimulate the student's intellectual involvement and contain all the necessary learning instructional activities that are capable of guiding the student through the course objectives. Therefore, the course / self-instructional material is completely equipped with everything that the syllabus prescribes.

To ensure effective instruction, a number of instructional design ideas are used and these help students to acquire knowledge, intellectual skills, motor skills and necessary attitudinal changes. In this respect, students' assessment and course evaluation are incorporated in the text.

The nature of instructional activities used in distance education self-instructional materials depends on the domain of learning that they reinforce in the text, that is, the cognitive, psychomotor and affective. These are further interpreted in the acquisition of knowledge, intellectual skills and motor skills. Students may be encouraged to gain, apply and communicate (orally or in writing) the knowledge acquired. Intellectual-skills objectives may be met by designing instructions that make use of students' prior knowledge and experiences in the discourse as the foundation on which newly acquired knowledge is built.

The provision of exercises in the form of assignments, projects and tutorial feedback is necessary. Instructional activities that teach motor skills need to be graphically demonstrated and the correct practices provided during tutorials. Instructional activities for inculcating change in attitude and behaviour should create interest and demonstrate need and benefits gained by adopting the required change. Information on the adoption and procedures for practice of new attitudes may then be introduced.

Teaching and learning at a distance eliminate interactive communication cues, such as pauses, intonation and gestures, associated with the face-to-face method of teaching. This is

particularly so with the exclusive use of print media. Instructional activities built into the instructional repertoire provide this missing interaction between the student and the teacher. Therefore, the use of instructional activities to affect better distance teaching is not optional, but mandatory.

Our team of successful writers and authors has tried to reduce this.

Divide and to bring this Self-Instructional Material as the best teaching and communication tool. Instructional activities are varied in order to assess the different facets of the domains of learning.

Distance education teaching repertoire involves extensive use of self-instructional materials, be they print or otherwise. These materials are designed to achieve certain pre-determined learning outcomes, namely goals and objectives that are contained in an instructional plan. Since the teaching process is affected over a distance, there is need to ensure that students actively participate in their learning by performing specific tasks that help them to understand the relevant concepts. Therefore, a set of exercises is built into the teaching repertoire in order to link what students and tutors do in the framework of the course outline. These could be in the form of students' assignments, a research project or a science practical exercise. Examples of instructional activities in distance education are too numerous to list. Instructional activities, when used in this context, help to motivate students, guide and measure students' performance (continuous assessment)

## **PREFACE**

We have put in lots of hard work to make this book as user-friendly as possible, but we have not sacrificed quality. Experts were involved in preparing the materials. However, concepts are explained in easy language for you. We have included many tables and examples for easy understanding.

We sincerely hope this book will help you in every way you expect.

All the best for your studies from our team!

# OPERATING SYSTEM AND SOFTWARE INSTALLATION

## Contents

---

### BLOCK 1 : OPERATING SYSTEM PRINCIPLES

---

#### Unit 1 Introduction to Operating System

Introduction, Definition of Operating System, Evolution of Operating Systems, Wiring-up Plug-boards, Serial Processing, Batch Processing, Spooling Batch Processing, Multi-Programming, Time Sharing, Real Time Processing, Network Processing, Distributed Processing, General Categories of Operating System

#### Unit 2 Structure and Services of Operating System

Introduction, Structure of Operating System, Monolithic OS Structure, Layered OS Structure, Virtual Machines, Exokernels, Client-Server Model, Microkernel, Services of Operating System, User Interface, System and Utility Function Calls, Process Control, File Management, Communication Management, Information Maintenance, Device Management, Program Execution, Input/Output Operations, File Management, Error Detection, Communication, Resource Allocation, Accounting, System Protection, Objectives of Operating System, System View as Resource Manager, Users View as Virtual Machine, Ability to Evolve as Software

#### Unit 3 Windows Operating System

Introduction, History of Windows OS, Microsoft OS for Servers and Mobile Devices, New Features of Windows 10

---

### BLOCK 2 : PROCESS MANAGEMENT

---

#### Unit 4 Process Management

Introduction, Overview of Process, Components of Process, Address Space, Processor State, OS Resources, Process States, Types of Process

**Unit 5      Threads and Concurrency**

Introduction, Multithreading, Thread implementation, User Space Thread, Kernel Space Thread, Hybrid Thread implementation, Thread Management, Concurrency and Its Problems, Inter-Process Communication, Concurrency Problem, Mutual Exclusion

**Unit 6      Process Scheduling**

Introduction, Overview of Process Scheduling, Scheduler, Long-Term Scheduler, Short-Term Scheduler, Scheduling, Process Scheduling Policies, Non Preemptive Scheduling, Pre-Emptive Scheduling, Context Switch and the Interrupt Handler, Scheduling Criteria, Scheduling Algorithms, First-Come First-Served (FCFS) Scheduling, Shortest Job First (SJF) Scheduling, Shortest Remaining Time Scheduling, Round Robin Scheduling (RR), Priority Scheduling, Multilevel Queue Scheduling, Thread Scheduling, Multiple Processor Scheduling

**Unit 7      Process Synchronization and Deadlocks**

Introduction, Dead lock Conditions, Resource-Allocation (R-A) Graph, Deadlock Handling Mechanisms, Deadlock Detection, Deadlock Recovery, Deadlock Avoidance, Deadlock Prevention

---

**BLOCK 3 : PROCESS MANAGEMENT**

---

**Unit 8      Memory Management**

Introduction, Swapping, Partitions, Paging, Implementation of Paging, Hierarchical Page Table, Address Translation With a 2-Level Page Table, Segmentation

**Unit 9      Page Replacement Algorithms**

Introduction, The Optimal Page Replacement Algorithm (PRA), The Not Recently Used (NRU) PRA, First In, First Out (FIFO) PRA, Second Chance PRA, Clock PRA, Last In, First Out (LIFO) PRA, Least Recently Used (LRU) PRA, The Aging PRA



**Unit 10      Device Management**

Introduction, Characteristics of I/O Devices, Principles of I/O Hardware, Principles of I/O Software, Disk, Disk Scheduling Algorithms

**Unit 11      File Systems**

Introduction, File Naming, File Types, File Attributes, File Operations

**Unit 12      Directories and File System Hierarchy**

Introduction, File Organization, Directory Organization, File System Hierarchy

**Unit 13      File System Implementation**

Introduction, File System Layout, File Storage Allocation Methods, Directory Implementation, File Sharing, Disk Space Management, File System Reliability, File System Consistency, File System Performance

---

**BLOCK 4 : PROTECTION, SECURITY AND SOFTWARE INSTALLATION**

---

**Unit 14      File System Implementation**

Introduction, Key Terms, System Security Objectives, System Security Attacks

**Unit 15      Protection**

Introduction, Design Principles of an Operating System, Cryptography, User Authentication, Access Control

**Unit 16      Operating System and Application Software Installation**

Introduction, Windows 10 Upgrade Installation, Windows 10 Clean installation, Windows 10 Out-Of-Box Experience, Install Microsoft 365 or Office 2019 on a PC



**BAOU**  
Education  
for All

Dr. Babasaheb Ambedkar  
Open University Ahmedabad

BCAR-102/  
DCAR-102

# **Operating System and Software Installation**

---

## **BLOCK 1 : OPERATING SYSTEM PRINCIPLES**

---

UNIT 1 INTRODUCTION TO OPERATING SYSTEM

UNIT 2 STRUCTURE AND SERVICES OF OPERATING SYSTEM

UNIT 3 WINDOWS OPERATING SYSTEM

# ***OPERATING SYSTEM PRINCIPLES***

## **Block Introduction :**

This block covers introduction to Operating System with definition, evolution of operating system and different types of operating systems. It includes the services and structure of operating systems as a whole. It focus on terminologies used, functionalities of an operating systems have and types of operating systems. The very foundations of operating system can be viewed from different perspectives.

Learner will get introduction to the Windows operating system (Windows OS) for personal computers which dominates the personal computer world. Block also covers evolution of today's Windows Operating System and features of Windows Operating System.

## **Block Objectives :**

The objective of this block is to define an Operating System and principles and objectives of the operating system with the corresponding aims they have. To describe the evolution stages of operating systems and general categories of OS, different software structures of operating systems, services provided by the operating systems, objectives of Operating System, evolution of Windows OS, features of Windows OS and discuss new features of windows 10

## **Block Structure :**

**Unit 1 : Introduction to Operating System**

**Unit 2 : Structure and Services of Operating System**

**Unit 3 : Windows Operating System**

**UNIT STRUCTURE**

- 1.0 Learning Objectives
- 1.1 Introduction
- 1.2 Definition of Operating System
- 1.3 Evolution of Operating Systems
  - 1.3.1 Wiring-up Plug-boards
  - 1.3.2 Serial Processing
  - 1.3.3 Batch Processing
  - 1.3.4 Spooling Batch Processing
  - 1.3.5 Multi-Programming
  - 1.3.6 Time Sharing
  - 1.3.7 Real Time Processing
  - 1.3.8 Network Processing
  - 1.3.9 Distributed Processing
- 1.4 General Categories of Operating System
- 1.5 Let Us Sum Up
- 1.6 Check Your Progress : Possible Answers
- 1.7 Assignment
- 1.8 Activity
- 1.9 Case Study
- 1.10 Further Reading

**1.0 Learning Objectives :**

After studying this unit learner should be able to :

- Define an Operating System State the principles and objectives of the operating system with the corresponding aims they have
- Describe the evolution stages of operating systems
- List general categories of OS

**1.1 Introduction :**

An operating system (OS) is a program that manages the computer hardware. It also provides a basis for application programs and acts as an intermediary between the computer user and the computer hardware. In this unit we provide a general overview of the major components of an operating system.

This unit introduces definition, evolution, structure and services of operating system. The operating system is a system software. This unit addresses the following questions :

- What are operating systems functionalities ?
- What are the activities performed by the modern operating systems ?
- What kind of software structure does it have ?

## **1.2 Definition of Operating System :**

Let us try to define what is operating system. Our focus is about the operating system software. What is it ?

### **What is Operating System ?**

Operating systems are system software that run on top of computer hardware. This definition needs to be observed from different perspectives of computer system, namely from application software and user hardware interaction.

Operating system can be defined as, system program that monitors works of application programs. It is responsible for the loading and execution of application programs. It has to make sure the availability of the required hardware and software requirements before executing the application program.

Operating system can also be defined as system software which acts as a bridge between the hardware and its users. The operating system, according to this definition, has a responsibility to hide the complexities of the underlying hardware for the end user. The end user is not supposed to know the details of hardware components like CPU, memory, disk drives, etc.

As we have discussed the definitions of operating system so far, we can conclude that the operating system is found between user, application software, and physical component of the computer system. It facilitates and monitors running of application programs and functions as a middle man between hardware and users.

### **❑ Check Your Progress – 1 :**

1. OS is a program that manages the computer software (True/False)
2. An Operating system is an example of system software (True/False)
3. OS functions as a middle man between hardware and users (True/False)
4. OS facilitates and monitors running of application programs (True/False)

## **1.3 Evolution of Operating Systems :**

Computers gone through different generations. The generations are classified based on varieties of criterion. One of the major criteria to classify computer generations is the type of operating system used. Evolution of operating systems has a close tie with the generation of computers. What were the basic changes made on operating systems over these generations ?

Studying evolution of Operating Systems is used to understand key requirements of an Operating System. Moreover, it helps to understand significance of the major features of modern Operating Systems.

Operating systems and computer architecture are historically tied. The combination of computer architecture with operating system is known as computer platform. Architectural changes affect structure and performance of Operating Systems. While studying the evolution of operating systems, consideration on the architecture is required.

Evolution of operating systems over the past decades has shown number of progresses from several perspectives. Starting from the point where machine does not have operating systems to a distributed processing capability. The foundation for the modern operating system was built over different parameters.

The following shows the major evolution of Operating Systems :

### **1.3.1 Wiring-Up Plug-Boards :**

Low level programming language called machine language was used to write computer instructions through wiring up plug-boards Plug-boards control the basic functions of the computer. No Operating Systems software were introduced. No programming languages to develop applications. No operators were required. Complex programming and machine underutilization.

### **1.3.2 Serial Processing :**

The technique is to running a single Job. Following are the working of serial processing :

- Developer creates his/her program and punches it on cards
- He/she submits the card deck to an operator in the input room
- he/she reserves machine time on a sign-up sheet
- Operator set-up the job as scheduled
- Operator carries over the returned output to the output room
- The developer will collect the output later

No Operating Systems software were introduced. No programming languages to develop applications.

#### **❖ Features :**

- Users get access in series
- Program writing was improved Disadvantages
- Wasted time due to scheduling and setup
- Wasted time while operators walk around the machine room
- Large machine/processor idle time

### **1.3.3 Batch Processing :**

The users of batch operating system do not interact with the computer directly. Each user prepares his job on an off-line device like punch cards and submits it to the computer operator. To speed up processing, jobs with similar needs are batched together and run as a group. Thus, the programmers left their programs with the operator. The operator then sorts programs into batches with similar requirements. The technique is to running a batch of Job.

#### **❖ Advantages :**

- Once the data process is started, the computer can be left running without supervision.
- Batch processing allows an organization to increase efficiency because a large amount of transactions can be combined into a batch rather than processing them each individually.

#### **❖ Disadvantages :**

- It is very difficult to maintain the priority between the batches.

## **Operating System and Software Installation**

- There is no direct interaction of user with computer. Lack of interaction between the user and job.
- CPU is often idle, because the speeds of the mechanical I/O devices is slower than CPU.
- Difficult to provide the desired priority.
- With batch processing there is a time delay before the work is processed and returned.

### **1.3.4 Spooling Batch Processing :**

#### **❖ Technique :**

- Adds up Spooling technique to simple batch processing
- Spooling – Simultaneous Peripheral Operation Online
- It is the ability to read jobs/print job outputs while the processor executes jobs
- Read jobs – from cards to disk
- Print job outputs – from disk to printer
- Used in input and output operations

With spooling, every time a currently executing task is completed, a new task is shipped from storage to the now-empty panel and be executed by the OS. Spooling is the first attempt of multiprogramming

#### **❖ Advantages :**

- Avoids CPU idle time between batches of jobs
- Improve turn-around time : Output of a job was available as soon as the job completed, rather than only after all jobs in the current cycle were finished.

#### **❖ Disadvantages :**

- Large turn-around time
- Large CPU idle time on heavily I/O bound jobs

### **1.3.5 Multi-Programming**

In a multiprogramming system there are one or more programs loaded in main memory which are ready to execute. Only one program at a time is able to get the CPU for executing its instructions (i.e., there is at most one process running on the system) while all the others are waiting their turn.

The main idea of multiprogramming is to maximize the use of CPU time. Indeed, suppose the currently running process is performing an I/O task (which, by definition, does not need the CPU to be accomplished). Then, the OS may interrupt that process and give the control to one of the other in-main-memory program that are ready to execute (i.e. process context switching). In this way, no CPU time is wasted by the system waiting for the I/O task to be completed, and a running process keeps executing until either it voluntarily releases the CPU or when it blocks for an I/O operation. Therefore, the ultimate goal of multi programming is to keep the CPU busy as long as there are processes ready to execute.

Note that in order for such a system to function properly, the OS must be able to load multiple programs into separate areas of the main memory and

provide the required protection to avoid the chance of one process being modified by another one. Other problems that need to be addressed when having multiple programs in memory is fragmentation as programs enter or leave the main memory. Another issue that needs to be handled as well is that large programs may not fit at once in memory which can be solved by using pagination and virtual memory.

❖ **Advantages :**

- Increase CPU utilization and reduce CPU idle time.
- It decreases total read time needed to execute a job as the jobs are in main memory.

❖ **Disadvantages :**

- Long response time : the elapsed time to return back a result for a given job was often several hours
- Poor interactivity between programmer and his program

### **1.3.6 Time Sharing :**

Multiple jobs are executed by the CPU by switching between them, but the switches occur so frequently. Thus, the user can receive an immediate response. For example, in a transaction processing, processor execute each user program in a short burst or quantum of computation. That is if n users are present, each user can get time quantum. When the user submits the command, the response time is in few seconds at most.

Operating system uses CPU scheduling and multiprogramming to provide each user with a small portion of atime. Computer systems that were designed primarily as batch systems have been modified to time-sharing systems.

❖ **Advantages :**

- More than one user can execute their task simultaneously.
- Avoids duplication of software
- CPU Idle time is reduced and better utilization of resources.
- Provide advantage of quick response.

❖ **Disadvantages :**

- Question of securing the security and integrity of user's data and programs.
- Since multiple processes are managed simultaneously, so it requires an adequate management of main memory
- Problem of reliability.

### **1.3.7 Real-Time Processing**

Real time system is defined as a data processing system in which the time interval required to process and respond to inputs is so small that it controls the environment. Real time processing is always on line whereas on line system need not be real time. The time taken by the system to respond to an input and display of required updated information is termed as response time. So, in this method response time is very less as compared to the online processing.

Real-time systems are used when there are rigid time requirements on the operation of a processor or the flow of data and real-time systems can be used as a control device in a dedicated application. Real-time operating



## **Operating System and Software Installation**

system has well-defined, fixed time constraints otherwise system will fail. For example, Scientific experiments, medical imaging systems, industrial control systems, weapon systems, robots, and home-appliance controllers, Air traffic control system etc. There are two types of real-time operating systems.

**Hard Real-Time Systems :** Hard real-time systems guarantee that critical tasks complete on time. In hard real-time systems secondary storage is limited or missing with data stored in ROM. In these systems virtual memory is almost never found.

**Soft Real-Time Systems :** Soft real time systems are less restrictive. Critical real-time task gets priority over other tasks and retains the priority until it completes. Soft real-time systems have limited utility than hard real-time systems. For example, Multimedia, virtual reality, Advanced Scientific Projects like undersea exploration and planetary rovers etc.

### ❖ **Advantages :**

- Better task scheduling as compared to manual process and time deadlines achievement is guaranteed in most of the cases.
- Accelerate the process by automanaging the system resources as in the case of Autopilot airplanes and railway e-ticket booking system.

### ❖ **Disadvantages :**

- If time dead lines are missed it may result in severe disastrous situation.
- Complex and need additional kernel, Memory and other resources are required.
- More vulnerable to security breaches like virus and unauthorized access.

### **1.3.8 Networked Processing :**

Comprise of several computers that are interconnected to one another. Each of these networked devices has their own local users and executes their own local OS not basically different from single computer OSs. Users also know about the presence of the several computers. Additional features needed by network operating systems are Network interface controller, NIC, A low-level software to drive it and software for remote login & remote file access.

### **1.3.9 Distributed Processing :**

A distributed system is a collection of physically separate, possibly heteroge-neous computer systems that are networked to provide the users with access to the various resources that the system maintains. Access to a shared resource increases computation speed, functionality, data availability, and reliability. Some operating systems generalize network access as a form of file access, with the details of networking contained in the network interface's device driver. Others make users specifically invoke network functions. Generally, systems contain a mix of the two modes—for example FTP and NFS. The protocols that create a distributed system can greatly affect that system's utility and popularity.

**Runs on a Multi-Computer System :** set of computers, each having its own memory, storage devices and other I/O modules. This is useful for distributing the task between these different computers. Existence of multiple computers is transparent to the user : It appears as a uniprocessor system. It differs in critical ways from uniprocessor OSs. Examples of distributed operating systems include LOCUS, MICROS, IRIX, Solaris, Mac/OS, and OSF/1.

❖ **Advantages :**

- With resource sharing facility user at one site may be able to use the resources available at another.
- Speedup the exchange of data with one another via electronic mail.
- If one site fails in a distributed system, the remaining sites can potentially continue operating.
- Better service to the customers.
- Reduction of the load on the host computer.
- Reduction of delays in data processing

❖ **Disadvantages :**

- Security problem due to sharing
- Some messages can be lost in the network system
- Bandwidth is another problem if there is large data then all network wires to be replaced which tends to become expensive
- Overloading is another problem in distributed operating systems
- If there is a database connected on local system and many users accessing that database through remote or distributed way then performance become slow
- The databases in network operating is difficult to administrate then single user system

❑ **Check Your Progress – 2 :**

1. Monitoring utilities were put to memory when required in simple batch processing systems (True/False)
2. In which type of system, the output of a program is sent to the disk and is printed only when the job completes ?
  - (a) Multi-programmed batch systems
  - (b) Batch systems with spooling
  - (c) Time sharing systems
  - (d) Multi-printing systems
3. A system that supports multiple processes per user is called a
  - (a) Multi-user system
  - (b) Multi-programming system
  - (c) Multi-tasking system
  - (d) None of the above
4. \_\_\_\_\_ operating system allows a computer to work independently as well as provides a means for sharing resources (e.g. files, printers, etc) to other computers connected to it.
  - (a) Real-time operating system
  - (b) Symmetric operating system
  - (c) Local area network
  - (d) Network operating system

**1.4 General Categories of Operating System :**

In above sections, we have introduced the general structure of a typical computer system. We have also seen that how the peripheral devices are attached to the processor and I/O between external and internal storage. There are different categories of the operating system according to the use and utilities provided by architecture.

## **Operating System and Software Installation**

**Desktop System :** The program controls the machine itself and provide services to the user of the machine only is called desktop or laptop operating system. This operating system takes the control of the hardware and run the environment to provide services like – memory management, process management, device access and data handling. Many systems of this category provide security and data protection. Examples are windows 10, Ubuntu 18.04 LTS, Mac OS 10.14 (Mojave) etc.

**Multiprocessor System :** System with two or more than two processors is known as multiprocessor system. This system shares common bus, clock, memory and devices. According to Flynn's classification, MISD (Multiple Instruction stream and Single Data stream) and MIMD (Multiple Instruction stream and Multiple Data stream) computers are of this category. Distributed system and clustered system are also part of multiprocessor system. When data stream and instruction stream are increased it effect the following parameters :

1. **Throughput :** Get more work done in less time. When more data and instruction stream are there, they can do the work simultaneously so the performance is increased. The speed-up ratio is increased for N processor work together but theoretically we are not getting increase according to number of processors. There are many reasons for that.
2. **Economy Scale :** MISD and MIMD architecture can use cluster of the computers and processors, that sharing external devices. This can be a cost effective solution in many cases.
3. **Reliability :** Failure of one processor will not affect other processing going on in the system, albeit load of the failed processor can be divided among other processors. This is user transparent mechanism so user don't have to bother about failure and system will be more reliable.

**Distributed System :** Distributed system is collection of physically separate, heterogeneous, and system that are networked to provide services. Sharable devices increase the speed of computation, data availability and reliability.

**Clustered System :** Cluster is usually used to provide high-availability services, when one of the nodes in the cluster is failed than other node takes charge of that node and start execution from where it is failed. There are mainly two types of clustered system– asymmetrical and symmetrical. In asymmetrical one node is standby mode so it can take the control of the failed node while symmetrical cluster all nodes are running simultaneously and monitor each other.

**Real Time System :** Real time system are special system that works on special requirements. The unique feature of this system is to complete the task in given deadline and instant service to the requisition generated in the environment. If task is not finished or handled in the given timeframe than it can cause the disaster. Major issue in the real time system is to develop a routine for proper scheduling of processes.

**Handheld System :** This category of the system includes PDA (Personal Digital Assistant) like tablets, cellular telephones etc. main issue of this system to manage data and application in limited amount of resources. Size of the device is small, processor rate is also slow, and amount of the memory is small to manage data.

### **1.5 Let Us Sum Up :**

An operating system is software that manages the computer hardware as well as providing an environment for application programs to run. Perhaps the most visible aspect of an operating system is the interface to the computer system it provides to the human user.

There are several different strategies for designing a computer system. Uniprocessor systems have only a single processor while multiprocessor systems contain two or more processors that share physical memory and peripheral devices. The most common multiprocessor design is symmetric multiprocessing (or SMP), where all processors are considered peers and run independently of one another. Clustered systems are a specialized form of multiprocessor systems and consist of multiple computer systems connected by a local area network.

To best utilize the CPU, modern operating systems employ multiprogramming, which allows several jobs to be in memory at the same time, thus ensuring the CPU always has a job to execute. Timesharing systems are an extension of multiprogramming whereby CPU scheduling algorithms rapidly switch between jobs, thus providing the illusion each job is running concurrently.

The operating system must ensure correct operation of the computer system. To prevent user programs from interfering with the proper operation of the system, the hardware has two modes : user mode and kernel mode. Various instructions (such as I/O instructions and halt instructions) are privileged and can be executed only in kernel mode. The memory in which the operating system resides must also be protected from modification by the user. A timer prevents infinite loops. These facilities (dual mode, privileged instructions, memory protection, and timer interrupt) are basic building blocks used by operating systems to achieve correct operation.

In this unit we have learned about Definition of Operating System, Evolution of Operating Systems, operating systems functionalities, activities performed by the modern operating systems.

### **1.6 Check Your Progress – Possible Answers :**

**❑ Check Your Progress 1 :**

1. False, 2. True, 3. True, 4. True

**❑ Check Your Progress 2 :**

1. False, 2. (b), 3. (c), 4. (d)

### **1.7 Assignments :**

- What is an operating system ?
- Write detailed note on evolution of operating system
- Write note on Simple Batch Processing
- Explain network operating system
- What is real time operating system ?

## **Operating System and Software Installation**

### **1.8 Activity :**

- Write Disadvantages of multiprogramming and timesharing
- Write difference between Network OS and Distributed OS

### **1.9 Case Study :**

- Explain general categories of Operating System

### **1.10 Further Reading :**

- Andrew S. Tanenbaum (2008). Modern Operating System. 3rd Edition. Prentice–Hall.
- A Silberschatz, Peter B Galvin, G Gagne (2009). Operating System Concepts. 8th Edition. Wiley.

**UNIT STRUCTURE**

- 2.0 Learning Objectives**
  - 2.1 Introduction**
  - 2.2 Structure of Operating System**
    - 1.3.1 Monolithic OS Structure**
    - 1.3.2 Layered OS Structure**
    - 1.3.3 Virtual Machines**
    - 1.3.4 Exokernels**
    - 1.3.5 Client–Server Model**
    - 1.3.6 Microkernel**
  - 2.3 Services of Operating System**
    - 2.4.1 User Interface**
    - 2.4.2 System and Utility Function Calls**
    - 2.4.3 Process Control**
    - 2.4.4 File Management**
    - 2.4.5 Communication Management**
    - 2.4.6 Information Maintenance**
    - 2.4.7 Device Management**
    - 2.4.8 Program Execution**
    - 2.4.9 Input/Output Operations**
    - 2.4.10 File Management**
    - 2.4.11 Error Detection**
    - 2.4.12 Communication**
    - 2.4.13 Resource Allocation**
    - 2.4.14 Accounting**
    - 2.4.15 System Protection**
  - 2.4 Objectives of Operating System**
    - 2.4.1 System View as Resource Manager**
    - 2.4.2 Users View as Virtual Machine**
    - 2.4.3 Ability to Evolve as Software**
  - 2.5 Let Us Sum Up**
  - 2.6 Check Your Progress : Possible Answers**
  - 2.7 Assignment**
  - 2.8 Activity**
  - 2.9 Case Study**
  - 2.10 Further Reading**
-

## **2.0 Learning Objectives :**

After studying this unit learner should be able to :

- Describe the different software structures of operating systems
- Determine the services provided by the operating systems
- List the Objectives of Operating System

## **2.1 Introduction :**

This unit providing the services and structure of operating systems as a whole. Focus on terminologies used, functionalities of an operating systems have and types of operating systems.

The very foundations of operating system can be viewed from different perspectives. Mainly, these perspectives focus on user and system level. Additionally, we can consider the operating system's nature as a software that requires to evolve through time depending on change on hardware as well as human needs. The principles that govern operating systems can be viewed from the following :

- System view as resource manager
- Users view as virtual machine
- Ability to evolve as software

## **2.2 Structure of Operating System :**

Any system as complex as the Operating System cannot be produced unless a structured approach is used. A number of structures have been used to develop the various operating systems that have been developed for the last five decades. In this unit five types of operating system structures will be discussed though several other structures exist. Tradeoffs between competing requirements are involved when designing an operating system. Major issues taken into consideration for the design of an operating system internal structure are :

### **❖ Performance Criteria :**

- Most Operating System's are designed to support user interactions.
- Launching new processes as well as responding to users input need to be fast

### **❖ Security Level :**

- Different level of security is desired according to the target environment
- Server OS vs workstation OS
- Correctness and maintainability :
- Well modularized code is easier to maintain
- Clean architecture is also an advantage

### **❖ Compatibility :**

- Backward compatibility is main requirement for an OS
- Codes difficult to be maintained are inevitable

❖ **Available Hardware :**

- Low-level functions of an OS often require hardware support such as protection mechanisms
- Can limit allowed commands

**2.2.1 Monolithic OS Structure :**

- It is also referred to as "The Big Mess" due to an absence of any kind of organization
- It consists of a bundle of procedures calling one another whenever they need to
- Each procedure has a well-defined interface in order to allow the programmer to use it in the development of other procedures.
- The object program of the operating system will be constructed by first compiling each procedure separately and then binding them all together into one object using the system linker

This structure is basically one big lump with no well separated functionality levels, no clearly defined internal interfaces and no level of encapsulation as every procedure is visible to all others. Example : MS-DOS.

The monolithic structure includes a little structure. It has clearly defined interfaces in that services of the Operating System are demanded by placing the required arguments in a well-defined area and then executing a trap instruction. The OS will then get the parameters and determines which service is being requested and indexes into a table that contains pointers to the procedures carrying out the services. In this case, the basic structure of the operating system can be summarized as :

- Main program invoking required system call procedure
- Collection of service modules to perform the system calls
- Collection of helpful programs assisting the service procedures

But the compiled code is still one big executable and changes in some part requires re-compiling the whole package. Example : most Linux Kernels.

**2.2.2 Layered OS Structure :**

- Hierarchical organization of an OS where each layer implements a function based on the layer beneath.
- The lower most level is the hardware and the uppermost level is the user interface
- High degree of encapsulation
- Easily maintainable and extendable
- With modularity, layers are arranged in such a way that each upper layer uses services of only the lower level layers
- This was the first OS designed with such structure by Dijkstra and his students
- It is a batch operating system with 6 layers



## Operating System and Software Installation

Layer	Name	Function
5	Operator	Interface for the system to operate
4	User programs	Enable users to perform an action
3	I/O Management	Controls I/O devices and buffers information stream to and from them
2	Operator console	Manages communication between processes and operator console
1	Memory management	Allocate space for processes
0	CPU scheduling	Processor allocation and Switching between processes when an interrupt occurs

### 2.2.3 Virtual Machines :

- This approach provides several Virtual Machines identical to the underlying bare hardware without any additional feature such as a file system.
- Considers the hardware and the operating system kernel together as a hardware
- Is used to separate the multiprogramming and extended machine functions found in timesharing operating systems
- The VM Controller that runs on the plain machine manages the multiprogramming and provides multiple virtual machines to the upper layers
- Virtual machines are created by sharing the physical machine's resources
- Exact copy of actual computer is given to every user process.
- The virtual machines can run different operating systems
- As each virtual machine is totally insulated from all other machines, there is a complete protection and thus high encapsulation however, resource sharing is difficult among the VMs
- VM in general, is difficult to implement as it requires an effort to create exact copy of the underlying machine

### 2.2.4 Exokernels :

- In such OS design, users are presented with a replica of the actual device but with only a portion of the device's resources
- The exokernel allocates resources to the available virtual machines and controls any attempt of accessing others resources.
- It has a main advantage of avoiding address mapping

### 2.2.5 Client–Server Model :

- Modern operating systems tend to move codes, as much as possible from the operating system up into upper levels to leave a minimal kernel or microkernel
- A so-called message passing is used to facilitate communication among user modules
- A user process called client process sends its request for a service to a server process

- The server process responds to the request by performing the required service and sending back the answer to the client process
- This structure splits the operating system into smaller and manageable parts each carrying out only one part of the system
- Easily maintainable and extendable as all server processes run in user mode
- Is more reliable and secure OS structure
- Easy to port the OS to new architectures
- It also has an advantage of being adaptable for distributed systems
- However, there is a performance overhead of user space to kernel space communication

### **2.2.6 Microkernel :**

- A microkernel OS is structured as a tiny kernel that provides the minimal services used by cooperating processes. These processes later provide the higher-level functionalities of operating system.
- The microkernel itself do not have file systems and several other functionalities which are required to be offered by an operating system.
- Microkernel provides a mechanism to implement the operating system.

#### **❑ Check Your Progress – 1 :**

1. MS-DOS has \_\_\_\_\_ type OS structure ?  
(a) Monolithic (b) Client-Server  
(c) Virtual Machines (d) Microkernel
2. In \_\_\_\_\_ OS Structure, users are presented with a replica of the actual device but with only a portion of the device's resources.  
(a) Monolithic (b) Layered (c) Exokernels (d) Microkernel
3. \_\_\_\_\_ is adaptable for distributed systems  
(a) Monolithic (b) Client-Server  
(c) Virtual Machines (d) Microkernel
4. The microkernel itself have file systems and several other functionalities which are required to be offered by an operating system. (True/False)
5. Virtual machines are created by sharing the physical machine's resources  
(True/False)
6. In Layered OS structure, the upper most level is the hardware and the lower most level is the user interface (True/False)

### **2.3 Services of Operating System :**

Operating system provides several services to users, programs as well as the whole machine. As system software, it acts as a bridge between users and the hardware in accepting user requests and interpreting them into machine executable commands. Processes directly consult the operating system for their various resource requests as well. Some of the basic services provided by an operating system are listed below.

### **2.3.1 User Interface :**

Users communicate with a computer system to use its resources through an interface provided by an operating system

The UI provided can be :

1. **Command Line Interface (CLI) :** allows direct command entry by fetching commands from user and executing it. it provides text-based interaction for the user where by users are forced to remember the label of each command. The commands range from a built-in to simple program names.
2. **Graphical User Interfaces (GUI) :** easy to use, user-oriented interfaces where users interact with the system through icons. These are user friendly desktop metaphor interfaces. Users pass their commands through keyboard, mouse and monitor.

### **2.3.2 System and Utility Function Calls :**

These are programming interfaces to the services provided by the operating system. Programs access these calls through an Application Program Interface (API)

They are written and used with a high-level programming language like C++. When implemented, each system call is associated with a number that is used for indexing.

The API invokes the required system call in the OS kernel and sends back the status of the system call along with any return value.

The API hides any detail of the OS from the caller. System calls can be about :

### **2.3.3 Process Control :**

Creating, terminating and waiting for a process

### **2.3.4 File Management :**

Create, read, write and delete files

### **2.3.5 Communication Management :**

Creating connections, sending message, receiving message, sharing memory

### **2.3.6 Information Maintenance :**

Getting/setting time, system data, file and process attributes

### **2.3.7 Device Management :**

Access, read, write devices

### **2.3.8 Program Execution :**

The OS is capable of loading a program onto main memory and run the program. It ends the execution of a program normally, if no errors are found, or terminates abnormally otherwise.

### **2.3.9 Input/Output Operations :**

Running programs mostly require input and output tasks.

The input/output can be either from/to file or I/O devices

It is the task of the OS to facilitate such kinds of requests coming from programs

### **2.3.10 File Management :**

The OS handles reading and writing files and directories

It also manages creation, deletion and searching of items in the files and directories Access Permission of files and directories is also the service of an OS.

### **2.3.11 Error Detection :**

Errors might occur in a system in different areas including CPU, memory, I/O devices or even user programs

The OS ensures correct and consistent operation of the system despite the errors occurred by taking the appropriate measurement on the detected errors. To do so, the OS requires to continuously inspect the system and identify possible errors.

### **2.3.12 Communication :**

Processes found on the same computer or over a networked computer might need to communicate among themselves

This communication can be carried out either through message passing or shared memory concept

The OS facilitates such communication among processes through implementing different communication management mechanisms

### **2.3.13 Resource Allocation :**

A computer system consists of several kinds of assets

Some of these resources such as the CPU and main memory need unique assignment code while others like the I/O devices might need a general request and release code to be accessed

It is the job of the OS to identify the type of resource required and run the appropriate code to access the resource Especially, in a multi-tasking and multi-user environment, the OS should be able to assign resources for each of the concurrently running jobs.

### **2.3.14 Accounting :**

The OS also keeps track of the number of users using the system,

It also maintains which users are using which kinds of resources and their consumption rate of the resource as well

### **2.3.15 System Protection :**

The OS controls all access to a systems' resource

It also enforces authentication and different access control mechanisms to keep the system free of undesired access attempts.

### **❑ Check Your Progress – 2 :**

1. The UI provided by OS can be \_\_\_\_\_  
(a) CLI (b) GUI  
(c) Either (a) or (b) (d) None of these
2. System calls provided by the OS can provide management of \_\_\_\_\_  
(a) Process Control (b) File  
(c) Device (d) All of these

3. This communication can be carried out through \_\_\_\_\_
  - (a) Message Passing
  - (b) Shared Memory Concept
  - (c) Either (a) or (b)
  - (d) None of these
4. The API hides any detail of the OS from the caller (True / False)
5. The OS handles reading and writing files and directories (True/False)
6. The OS does not require to continuously inspect the system to identify possible errors (True/False)

## **2.4 Objectives of Operating System :**

The very foundations of operating system can be viewed from different perspectives. Mainly, these perspectives focus on user and system level. How is the operating system perceived from user view, hardware view, and as a software ?

### **2.4.1 System View as Resource Manager :**

For the computer system, an operating system is a software that closely interacts with the hardware. A computer system has a collection of components for moving, processing and storing data. Thus, from the machine point of view, an operating system can be considered as resource manager and allocator. A number of resource requests that may also possibly be conflicting comes to the system and the operating system should choose how to assign them to particular programs and users and ensure the system is performing efficiently and fairly. The operating system should also handle different I/O devices and application software found in a computer system so that bugs and improper use of the system is prevented.

### **2.4.2 Users View as Virtual Machine :**

Most Computer users have a PC with system unit, monitor, keyboard and mouse. In other cases, users might sit at a terminal connected to large computers as mainframe and minicomputer or at workstations connected to other networked workstations. In all these cases, requirements of users totally vary. In the case of a PC, the system is designed only for single user and the user is allowed to monopolize all the resources; the goal is maximizing the service that the user obtains. Thus, the operating system is designed to provide simple use, with some considerations to performance but nothing to resource utilizations.

In the second case where users are sitting at a terminal, there are also other users sharing the same resource with them in their respective terminals. For such cases, the operating system should be designed in such a way that the main concern is resource utilization to guarantee efficient usage of all available resources such as CPU time, main memory and I/O and everyone is sharing the resources fairly. In the latter case that involves a workstation, users have both dedicated resources at their disposal and also share resources like file servers or print servers with others. The operating system for such cases should be designed to compromise between resource utilization and individual usability.

Considering all these and other circumstances of users' requirement, an operating system is a system designed to provide an easy-to-work-in environment for users and manage all the possible needs of its users regardless of the resource scarcity.

### 2.4.3 Ability to Evolve as Software :

The operating system is a system software that bridges hardware with the rest of the computer components.

The operating system is the software that communicates with the software, i.e., device drivers, of the hardware which are the products of different vendors. If there are any changes on the hardware peripherals, then the vendors change the device drives of the hardware. Thus, these changes need to be incorporated in the operating system.

The operating system, as discussed in unit 1, is responsible services to the user. If the user is requiring additional services, the operating system has to deliver those services, too.

As a software, the operating system might have a bug. Later on, usage of the operating system will result in error on the operating system. These bugs must be fixed.

The addition of hardware resources, need for new services, and maintenance of bugs has to be done on the next version of the operating system. Every version of the operating system has at least one of the following features :

- Capability to recognize a new hardware
- New service(s)
- Fixed bugs

#### **Check Your Progress – 3 :**

1. A computer system has a collection of components for \_\_\_\_\_ data  
(a) Moving (b) Processing (c) Storing (d) All of these
2. An operating system is a system designed to provide \_\_\_\_\_  
(a) Easy-to-work-in environment  
(b) Manage all the possible needs of its users regardless of the resource scarcity  
(c) Both (a) and (b)  
(d) None of these
3. As a software, the operating system might have a bug (True / False)
4. From the user point of view, an operating system can be considered as resource manager and allocator (True/False)
5. If the user is requiring additional services, the operating system has to deliver those services, too. (True/False)
6. The OS should be designed to guarantee efficient usage and sharing of all available resources by everyone fairly. (True/False)

### **2.5 Let Us Sum Up :**

It is impractical to design and implement an operating system, which is a large and complex software, without having a certain structuring method. There are various models for the structure of operating systems. The main five models are : monolithic structure, layered structure, virtual machines, exokernels and client server structure. The Operating System is the glue that binds users request and systems' response together by facilitating an abstracted and easy to use environment for the users and providing other several services to programs as well.

Operating system provides number of services like user interface, program execution, system protection, accounting, input/output management, file management, error handling, etc. In this unit we have lean about Structure of Operating System, Services of Operating System and Objectives of Operating System

**2.6 Check Your Progress : Possible Answers :**

**Check Your Progress 1 :**

1. (a), 2. (b), 3. (c), 4. False, 5. True, 6. False

**Check Your Progress 2 :**

1. (a), 2. (d), 3. (c), 4. True, 5. True, 6. False

**Check Your Progress 3 :**

1. (a), 2. (b), 3. True, 4. False, 5. True, 6. True

**2.7 Assignments :**

- What are the major issues considered when the internal structure of operating system is designed ?
- What is the worst–case scenario of the monolithic structure of operating system ?
- What is a microkernel ?

**2.8 Activity :**

- List at least four services of the operating system.

**2.9 Case Study :**

- Discuss the different layers of layered operating system structure ?

**2.10 Further Reading :**

- Andrew S. Tanenbaum (2008). Modern Operating System. 3rd Edition. Prentice–Hall.
- A Silberschatz, Peter B Galvin, G Gagne (2009). Operating System Concepts. 8th Edition. Wiley.

**UNIT STRUCTURE**

- 3.0 Learning Objectives**
- 3.1 Introduction**
- 3.2 History of Windows OS**
- 3.3 Microsoft OS for Servers and Mobile Devices**
- 3.4 New Features of Windows 10**
- 3.5 Let's Sum up**
- 3.6 Check Your Progress : Possible Answers**
- 3.7 Assignments**
- 3.8 Activities**
- 3.9 Case Study**
- 3.10 Further Reading**

**3.0 Learning Objectives :**

Upon completion of this unit you should be able to :

1. Describe Evolution of Windows OS
2. List features of Windows OS
3. Understand new features of windows 10

**3.1 Introduction :**

The Windows operating system (Windows OS) are more formally called Microsoft Windows and is actually a family of operating systems for personal computers. Windows dominates the personal computer world, running, by some estimates, more than 90 percent of all personal computers – the remainder running Linux and Mac operating systems.

Windows provides a graphical user interface (GUI), virtual memory management, multitasking, and support for many peripheral devices. In addition to Windows operating systems for personal computers, Microsoft also offers operating systems for servers and mobile devices. In this unit we will learn about evolution of today's Windows Operating System and features of Windows Operating System.

**3.2 History of Windows OS :**

The following details the history of MS-DOS and Windows operating systems designed for personal computers (PCs). Microsoft Windows is a family of operating systems. We look at the history of Microsoft's Windows operating systems (Windows OS) from 1985 to present day.

**❖ MS-DOS – Microsoft Disk Operating System (1981) :**

Originally developed by Microsoft for IBM, MS-DOS was the standard operating system for IBM-compatible personal computers. The initial versions



of DOS were very simple and resembled another operating system called CP/M. Subsequent versions have become increasingly sophisticated as they incorporated features of minicomputer operating systems.

❖ **Windows 1.0 – 2.0 (1985–1992) :**

Introduced in 1985, Microsoft Windows 1.0 was named due to the computing boxes, or "windows" that represented a fundamental aspect of the operating system. Instead of typing MS-DOS commands, windows 1.0 allowed users to point and click to access the windows. In 1987 Microsoft released Windows 2.0, which was designed for the designed for the Intel 286 processor. This version added desktop icons, keyboard shortcuts and improved graphics support.

❖ **Windows 3.0 – 3.1 (1990–1994) :**

Windows 3.0 was released in May, 1990 offering better icons, performance and advanced graphics with 16 colors designed for Intel 386 processors. This version is the first release that provides the standard "look and feel" of Microsoft Windows for many years to come. Windows 3.0 included Program Manager, File Manager and Print Manager and games (Hearts, Minesweeper and Solitaire). Microsoft released Windows 3.1 in 1992.

❖ **Windows 95 (August 1995) :**

Windows 95 was released in 1995 and was a major upgrade to the Windows operating system. This OS was a significant advancement over its precursor, Windows 3.1. In addition to sporting a new user interface, Windows 95 also includes a number of important internal improvements. Perhaps most important, it supports 32-bit applications, which means that applications written specifically for this operating system should run much faster.

Although Windows 95 can run older Windows and DOS applications, it has essentially removed DOS as the underlying platform. This has meant removal of many of the old DOS limitations, such as 640K of main memory and 8-character filenames. Other important features in this operating system are the ability to automatically detect and configure installed hardware (plug and play).

❖ **Windows 98 (June 1998) :**

Windows 98 offers support for a number of new technologies, including FAT32, AGP, MMX, USB, DVD, and ACPI. Its most visible feature, though, is the Active Desktop, which integrates the Web browser (Internet Explorer) with the operating system. From the user's point of view, there is no difference between accessing a document residing locally on the user's hard disk or on a Web server halfway around the world.

❖ **Windows ME – Millennium Edition (September 2000) :**

The Windows Millennium Edition, called "Windows Me" was an update to the Windows 98 core and included some features of the Windows 2000 operating system. This version also removed the "boot in DOS" option.

❖ **Windows NT 3.1 – 4.0 (1993–1996) :**

A version of the Windows operating system. Windows NT (New Technology) is a 32-bit operating system that supports preemptive multitasking. There are actually two versions of Windows NT : Windows NT Server, designed to act as a server in networks, and Windows NT Workstation for stand-alone or client workstations.

❖ **Windows 2000 (February 2000) :**

Often abbreviated as "W2K," Windows 2000 is an operating system for business desktop and laptop systems to run software applications, connect to Internet and intranet sites, and access files, printers, and network resources. Microsoft released four versions of Windows 2000 : Professional (for business desktop and laptop systems), Server (both a Web server and an office server), Advanced Server (for line-of-business applications) and Datacenter Server (for high-traffic computer networks).

❖ **Windows XP (October 2001) :**

Windows XP was released in 2001. Along with a redesigned look and feel to the user interface, the new operating system is built on the Windows 2000 kernel, giving the user a more stable and reliable environment than previous versions of Windows. Windows XP comes in two versions, Home and Professional. Microsoft focused on mobility for both editions, including plug and play features for connecting to wireless networks. The operating system also utilizes the 802.11x wireless security standard. Windows XP is one of Microsoft's best-selling products.

❖ **Windows Vista (November 2006) :**

Windows Vista offered an advancement in reliability, security, ease of deployment, performance and manageability over Windows XP. New in this version was capabilities to detect hardware problems before they occur, security features to protect against the latest generation of threats, faster start-up time and low power consumption of the new sleep state. In many cases, Windows Vista is noticeably more responsive than Windows XP on identical hardware. Windows Vista simplifies and centralizes desktop configuration management, reducing the cost of keeping systems updated.

❖ **Windows 7 (October, 2009) :**

Windows 7 was released by Microsoft on October 22, 2009 as the latest in the 25-year-old line of Windows operating systems and as the successor to Windows Vista (which itself had followed Windows XP). Windows 7 was released in conjunction with Windows Server 2008 R2, Windows 7's server counterpart. Enhancements and new features in Windows 7 include multi-touch support, Internet Explorer 8, improved performance and start-up time, Aero Snap, Aero Shake, support for virtual hard disks, a new and improved Windows Media Center, and improved security.

❖ **Windows 8 :**

Windows 8 was released on August. 1, 2012 and is a completely redesigned operating system that's been developed from the ground up with touchscreen use in mind as well as near-instant-on capabilities that enable a Windows 8 PC to load and start up in a matter of seconds rather than in minutes.

Windows 8 will replace the more traditional Microsoft Windows OS look and feel with a new "Metro" design system interface that first debuted in the Windows Phone 7 mobile operating system. The Metro user interface primarily consists of a "Start screen" made up of "Live Tiles," which are links to applications and features that are dynamic and update in real time. Windows 8 supports both x86 PCs and ARM processors.

❖ **Windows 10 :**

Windows 10 is Microsoft's Windows successor to Windows 8. Windows 10 debuted on July 29, 2015, following a "technical preview" beta release of the new operating system that arrived in Fall 2014 and a "consumer preview" beta in early 2015. Microsoft claims Windows 10 features fast start up and resume, built-in security and the return of the Start Menu in an expanded form. This version of Windows will also feature Microsoft Edge, Microsoft's new browser. Any qualified device (such as tablets, PCs, smartphones and Xbox consoles) can upgrade to Windows 10, including those with pirated copies of Windows.

**3.3 Microsoft Operating Systems for Servers and Mobile Devices :**

Aside from operating systems designed for use on personal computers (PCs) and laptops, Microsoft has also developed operating systems for services, handheld devices, and mobile phones.

❖ **Windows Server (March 2003) :**

Windows Server is a series of Microsoft server operating systems. Windows servers are more powerful versions of their desktop operating system counterparts and are designed to more efficiently handle corporate networking, Internet/intranet hosting, databases, enterprise-scale messaging and similar functions. The Windows Server name made its debut with the release of Windows Server 2003 and continues with the current release, Windows Server 2008 R2, which shares its codebase with Windows 7. Windows Server 2008 R2 debuted in October 2009.

❖ **Windows Home Server (January 2007) :**

Announced in January 2007, Windows Home Server (WHS) is a "consumer server" designed to use with multiple computers connected in the home. Home Server allows you to share files such as digital photos and media files, and also allows you to automatically backup your home networked computers. Through Windows Media Connect, Windows Home Server lets you share any media located on your WHS with compatible devices.

❖ **Windows CE (November 2006) :**

A version of the Windows operating system designed for small devices such as personal digital assistants (PDAs) (or Handheld PCs in the Microsoft vernacular). The Windows CE graphical user interface (GUI) is very similar to Windows 95 so devices running Windows CE should be easy to operate for anyone familiar with Windows 95.

❖ **Windows Mobile (April 2000) :**

A mobile operating system for smartphones and mobile devices from Microsoft based on the Windows CE kernel and designed to look and operate similar to desktop versions of Microsoft Windows. Windows Mobile has largely been supplanted by Windows Phone 7, although Microsoft did release, in 2011, Windows Embedded Handheld 6.5, a mobile OS compatible with Windows Mobile 6.5 that's designed for enterprise mobile and handheld computing devices.

❖ **Windows Phone (November 2010) :**

Windows OS – Windows Phone

A mobile operating system for smartphones and mobile devices that serves as the successor to Microsoft's initial mobile OS platform system, Windows Mobile. Unlike Windows Mobile, Windows Phone 7 (also referred to as WinPhone7) is targeted more to the consumer market than the enterprise market, and it replaces the more traditional Microsoft Windows OS look and feel with a new "Metro" design system user interface.

Windows Phone 7 features a multi-tab Internet Explorer Mobile Web browser that uses a rendering engine based on Internet Explorer 9 as well Microsoft Office Mobile, a version of Microsoft Office that's tailored for mobile devices. Its successors include Windows Phone 8 and Windows 10 Mobile.

**3.4 New Features of Windows 10 :**

Windows 10 is the most recent version of the Microsoft Windows operating system. While older versions of Windows mainly ran on desktop and laptop computers, Windows 10 is also designed to run equally well on tablets.

❖ **Start Menu :**

Whereas Windows 8 uses the Start screen to launch applications, Windows 10 has reintroduced a more traditional Start menu. It's also been expanded to make it easier to find important apps.

❖ **Microsoft Edge**

This new browser is designed to give Windows users a better experience on the Web. It's faster, more secure, and includes a lot of new features. Microsoft Edge is meant to replace Internet Explorer as your default web browser, but you'll still be able to use IE (or another browser) if you prefer.

❖ **Cortana :**

Similar to Siri and Google Now, you can talk to this virtual assistant with your computer's microphone. Cortana can answer questions like What's the weather like today ?, perform simple tasks like remind you to take out the trash, and much more.

❖ **Multiple Desktops and Task View :**

Instead of keeping everything open on the same desktop, you can move some of your windows to a virtual desktop to get them out of the way. And the new Task view feature makes it easy to manage all of your open windows.

❖ **Action Center**

The new Action Center is pretty different from previous versions of Windows. For example, it's been expanded to let you access frequently used settings, such as Wi-Fi connectivity and tablet mode. It's also where you'll see important **notifications**, so if your computer receives an update you'll get a notification about it here.

❖ **Tablet Mode :**

Unlike Windows 8, Windows 10 makes a clear distinction between desktops and tablets. If you're using a keyboard and mouse with Windows 10, you'll be in desktop mode by default. If your computer also has a touchscreen, you can go into tablet mode at any time. Tablet users can also switch back to desktop mode if they prefer.

**❑ Check Your Progress – 1 :**

1. Windows-7 launch in the year \_\_\_\_\_  
(a) 2007                      (b) 2008                      (c) 2009                      (d) 2010
2. Which of the following is a new feature in windows 10  
(a) Microsoft Edge                      (b) Cortana  
(c) Tablet Mode                      (d) All of these
3. Windows XP comes in two versions, Home and Professional.
4. Windows NT (New Technology) is a 64-bit operating system that supports preemptive multitasking. (True / False)
5. Windows CE is designed to look and operate similar to desktop versions of Microsoft Windows. (True/False)
6. Windows 10 has reintroduced a more traditional Start menu. It's also been expanded to make it easier to find important apps.. (True/False)
7. Windows 10 makes a clear distinction between desktops and tablets..  
(True/False)
8. Windows 8 is a completely redesigned operating system that's been developed from the ground up with touchscreen and enable a Windows 8 PC to load and start up in a matter of seconds rather than in minutes.  
(True/False)

**3.5 Let's Sum Up :**

In this unit we have learn about windows operating system and evolution of Windows Operating System, Microsoft Operating Systems for Servers and Mobile Devices and understand new features of windows 10.

**3.6 Check Your Progress : Possible Answers :**

**❑ Check Your Progress 1 :**

1. (a),      2. (b),      3. True,      4. False
5. True,      6. True,      7. True,      8. True

**3.7 Assignment :**

- Write detailed note on history of Windows OS
- Explain new features of Windows 10 Operatiing System

**3.8 Activities :**

- Explore new features of windows 10 operating system

**3.9 Case Study :**

- Study Microsoft Operating Systems for Servers and Mobile Devices

**3.10 Further Reading :**

- [https://www.webopedia.com/DidYouKnow/Hardware\\_Software/history\\_of\\_microsoft\\_windows\\_operating\\_system.html](https://www.webopedia.com/DidYouKnow/Hardware_Software/history_of_microsoft_windows_operating_system.html)
- <https://www.microsoft.com/en-in/windows/features?activetab=feature-pivot%3aprimar2>

**BLOCK SUMMARY :**

- An operating system is software that manages the computer hardware as well as providing an environment for application programs to run
- To best utilize the CPU, modern operating systems employ multiprogramming, which allows several jobs to be in memory at the same time, thus ensuring the CPU always has a job to execute.
- Timesharing systems are an extension of multiprogramming whereby CPU scheduling algorithms rapidly switch between jobs, thus providing the illusion each job is running concurrently.
- The operating system must ensure correct operation of the computer system.
- The main five models of operating systems are : monolithic structure, layered structure, virtual machines, exokernels and client server structure.
- Operating system provides number of services like user interface, program execution, system protection, accounting, input/output management, file management, error handling, etc.

**BLOCK ASSIGNMENT :**

**Short Questions**

- What is operating system ?
- What is kernel mode ?
- What is Multi-programming ?
- What is time sharing OS ?
- What is network operating system ?
- What is windows operating system ?
- What is Exokernels architecture ?

**Long Question**

- Write detailed note on General Categories of Operating System
- Explain in details about Services of Operating System
- Describe objectives of operating system
- Write detailed note on windows operating system with its features



Dr. Babasaheb Ambedkar  
Open University Ahmedabad

BCAR-102/  
DCAR-102

# **Operating System and Software Installation**

---

## **BLOCK 2 : PROCESS MANAGEMENT**

---

UNIT 4 PROCESS MANAGEMENT

UNIT 5 THREADS AND CONCURRENCY

UNIT 6 PROCESS SCHEDULING

UNIT 7 PROCESS SYNCHRONIZATION AND DEADLOCKS

# ***PROCESS MANAGEMENT***

## **Block Introduction :**

This block covers overview of process with definition, component of process, process states and types of process. It provides Introduction to Multithreading, Thread implementation, Thread Management and Concurrency and Its Problems

The two main objectives of the process scheduling are to keep the CPU busy at all times and to deliver "acceptable" response times for all programs, particularly for interactive ones. This block define scheduling, scheduler and types of scheduler It also describes process scheduling policies and explains types of scheduling algorithms

A deadlock situation may occur in the system such as mutual exclusion, hold and wait, no pre-emption, and circular wait. A system can use four different techniques in order to protect itself from a deadlock situation by determining which process sequencing is safe or not. This block explains deadlock conditions and its prevention.

## **Block Objectives :**

The most central notion in any operating system is a process. The objective of this block is to define process and components of process and how process is managed, it also describes process life cycle and different process states. Multi-threading brings many advantages to processes. This block also discuss thread and types of thread implementation, concurrency problem, Interprocess Communication mechanism and mutual exclusion.

Scheduling is a means through which fair distribution of execution time is granted to processes with similar state for a multiprogramming system. The objective of this block is to define scheduling, scheduler and types of scheduler, it describe process scheduling policies and types of scheduling algorithms and important terminology.

Deadlock is one of the problems of concurrency. In a multiprogramming environment, processes compute for resources, The objective of this block is to define dead lock and describe necessary condition for deadlock, a Resource-Allocation (R-A) Graph and explains Deadlock Handling Meachnism

## **Block Structure :**

**Unit 4 : Process Management**

**Unit 5 : Threads and Concurrency**

**Unit 6 : Process Scheduling**

**Unit 7 : Process Synchronization and Deadlocks**



**UNIT STRUCTURE**

- 4.0 Learning Objectives
- 4.1 Introduction
- 4.2 Overview of Process
- 4.3 Components of Process
  - 4.3.1 Address Space
  - 4.3.2 Processor State
  - 4.3.3 OS Resources
- 4.4 Process States
- 4.5 Types of Process
- 4.6 Let's Sum up
- 4.7 Check Your Progress : Possible Answers
- 4.8 Assignments
- 4.9 Activity
- 4.10 Case study
- 4.11 Further Reading

**4.0 Learning Objectives :**

Upon completion of this unit you should be able to :

1. Define process and components of process
2. Describe how process is managed
3. Explain process life cycle
4. List different process states

**4.1 Introduction :**

The most central notion in any operating system is a process. A process is a program currently running and that needs different kinds of resources to be allocated. A process also interacts with other processes more frequently. Thus, an operating system is responsible to manage all the requirements of processes and also coordinate communication among different processes. This unit covers in detail processes, types of processes, the different states of a process in process life cycle.

**4.2 Overview of Process :**

One of the fundamental functionalities of operating system is process management. What is process ? What types does it have ?

Early computer systems were capable of running only one program at a time and the program had full control of the systems' resources and thus no structuring is required. But today's computer systems are designed to support multiprogramming, running more than one program concurrently, besides the operating system they have.

This arrangement requires the system to know which is which so that going back and forth between the programs is possible and thus enforces the need for structuring. Process is an instance of a program that is being executed. It is a program that has been loaded from disk onto memory and is running. While a program is just a passive set of commands, process is the actual execution of these instructions and one program can be partitioned to more than one processes. It is the basic unit of execution in an operating system. A process consumes some amount of assets like CPU time, main memory, and I/O devices to carry out its operations. It is the duty of the operating system to manage all these requirements of processes and bring them to termination.

A process is the basic execution unit in an operating system with unique number assigned as an identifier (PID). Though the CPU is running only one program at a time, it may also work on multiple programs by switching and running them for tens or hundreds of milliseconds. This in turn requires more control and partitioning of programs which resulted in a process. Thus, the operating system will have many processes running at the same time all requiring resources.

### **4.3 Components of Process :**

A process has three main components namely address space, processor state and OS resources.

#### **4.3.1 Address Space :**

Address space is a memory location that the process can access. It is how a process sees its memory. Every process has a separate address space. An address space encompasses many parts like the instructions, local variables, heap, stack, etc. as can be seen in the figure 1.1

**Text Segment/Code Section** holds the executable Code of the program which is read from secondary storage when the program is launched

**Data Segment** maintains static variables and initialized Global variables prior to the execution of main

**Heap** is used for dynamically allocated memory during run time and it is managed through new, delete, malloc, etc. calls.

**Stack Segment** holds all local variables and saved registers for each procedure call. The stack will be freed when the variables go out of scope

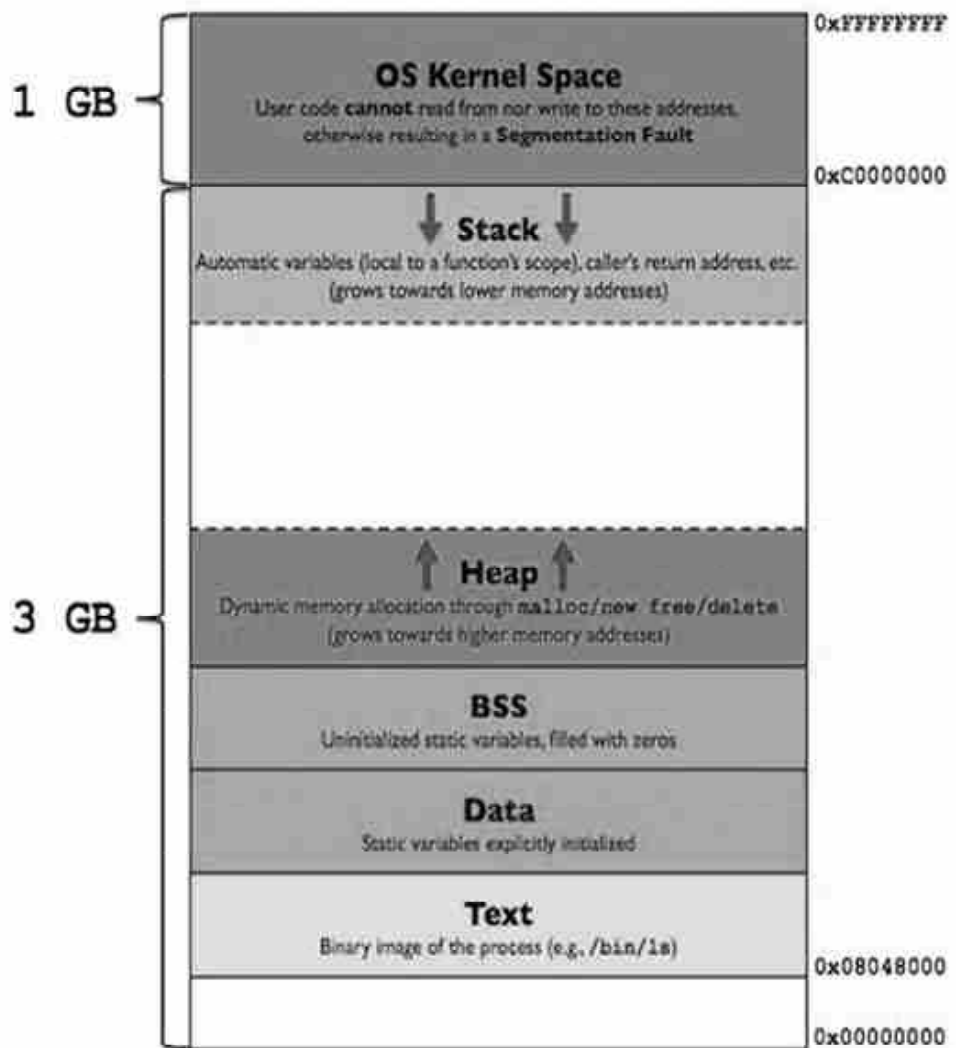

Fig. 4.1 : A Process in Memory

#### 4.3.2 Processor State :

Processor state are CPU registers associated with the running process. The registers hold the results so far of running the code of the process. It includes general purpose registers, program counter, stack counter, etc. the information on these registers must be stored and restored as the processes swap out of memory and later restored.

#### 4.3.3 OS Resources :

OS resources : the different OS state related with the process. Examples : open files, network sockets, etc. The operating system maintains a process table to store these details of each process.

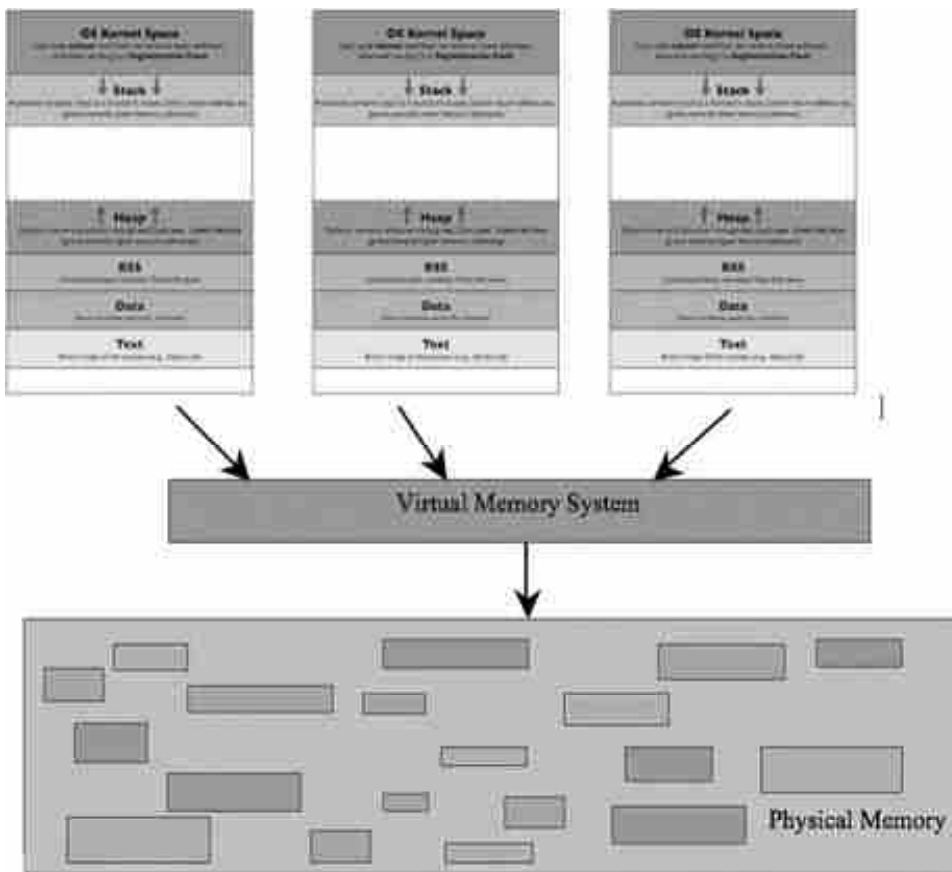

**Fig. 4.2 : Conceptual Model of Multiprocessing**

A conceptual model to simplify the management of several parallel processes is being used while designing an operating system. The design organizes all executable programs on a system into a number of sequential processes. The CPU has a multiprogramming capability where it switches between processes back and forth to manage their execution. Every process has its own virtual program counter that will be placed onto the actual physical program counter of the system when the process runs as shown in figure 1.2. below. And when the process finishes its execution for now, the content of the actual program counter is maintained in the processes' logical counter in memory. Processes shall not be developed with built-in timing assumptions as the amount at which a process carries out its operations may not be consistent due to the back and forth movement of CPU among processes.

A general-purpose operating system allows for processes to execute concurrently and needs a mechanism for creation and termination of processes as needed during operation to assure all necessary processes exist. There are three basic situations for a process creation. These are :

**System initialization :** Several processes are created at system boot time. These processes can be either foreground processes that allow users to accomplish a task or background processes known as daemons that handles a specific activity for the system such as web page or print handling and are not associated with a specific user. The ps program and task manager are used to list processes in UNIX and Windows operating system respectively.

**Running process :** executing process creation system calls

Sometimes, a running process requests a system call for creating new processes to assist it on its jobs if the job can easily be formulated into multiple inter-related but independent communicating processes.

**User request :** New process can also be created when a user types a command or double clicks an icon to start a program. If the operating system has a command-based interface, the new process uses the window in which it was created. On the other hand, if the operating system is graphical, a process do not have a window when started so it creates one. In both cases, users can have multiple windows opened simultaneously and they can interact with the processes through a mouse click.

The other way in which processes can be created is through batch systems found on mainframe computers. In such cases, users give bunch of tasks to the computer and if the operating system has the required resources to entertain another task, it produces the new process requested.

In all the process creation cases discussed, a process creation system call is executed from an already existing process to create the new one. The operating system will be informed by the system call to create the new process and which program to run in it. The system call used to create new processes in UNIX is fork (). Fork makes an exact replica of the calling process which results in parent and child processes. These processes have the same memory image, environment string and open files. The child process can then execute the execve system call to create its own memory image and run a new program.

CreateProcess is the system call used to create new process in windows operating system.

❑ **Check Your Progress – 1 :**

1. Process is an instance of a program that is being executed. (True/False)
2. Which of the following is a process state ?  
(a) Ready      (b) Running      (c) Waiting      (d) All of these
3. \_\_\_\_\_ is a memory location that the process can access  
(a) Address Space      (b) Processor State  
(c) Resources      (d) None of these
4. There are four basic situations for a process creation. (True/False)
5. The system call used to create new processes in UNIX is fork ().  
(True/False)
6. Stack segment is used for dynamically allocated memory during run time and it is managed through new, delete, malloc, etc. calls. (True/False)

**4.4 Process States :**

Starting from the execution of process, it passes through different states till its termination. What are those states ? How is the transition from one state to another invoked ?

The state of a process changes while the process is running. The state indicates what the process is currently doing. A process can assume any one of the following three states.

- **Ready :** the process is ready to go but is waiting to get granted the CPU as some other process is using it.
- **Running :** the process is actually using the CPU at the moment and is being executed.

- **Waiting** : sleeping or blocked state where the process is waiting for an event. Even if the CPU is free to handle requests, a process at this state will not use it as it is waiting for some external events to occur.

Four possible moves can be made by a process between these states as it executes as shown in figure 1.3 below.

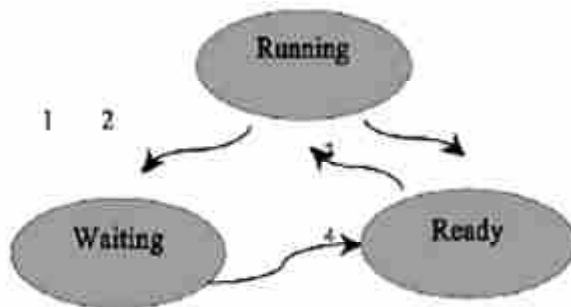

Fig. 4.3 : Process Transitions Between States

Transition 1 happens when a process has to wait for some event like I/O and can't continue further. Transition 2 and 3 happens when the process scheduler decides so without the knowledge of the process. In transition 2, the scheduler decides that the process has run long enough and it is time to let others use the CPU or an interrupt has occurred which signals the CPU to stop the current process and do some other activity. In transition 3, the scheduler decides the other processes have enough use of the CPU and it is this process's turn to use the CPU again. The last transition, transition 4, occurs when the process has got what it was waiting for and jumps immediately to ready state where it is moved to the running state, if the CPU is idle, or remains in the ready state until the CPU is idle. It is important to note that several processes can be in ready and waiting state while only one process is running at any instant of time.

A process's life cycle comprises of five basic states as new, ready, running, waiting and terminate phase.

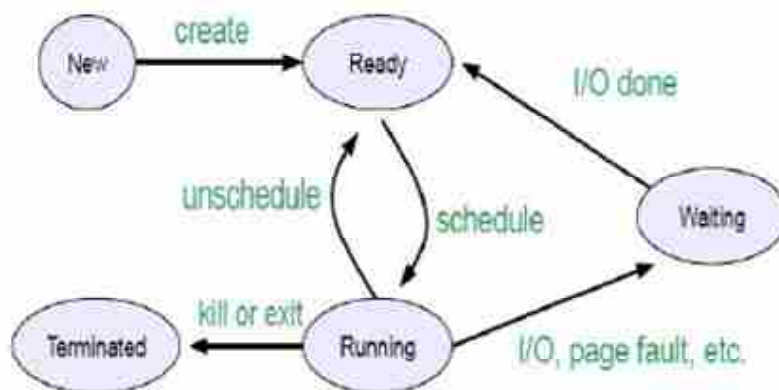

Fig. 4.4 : Life Cycle of a Process

The operating system represents each process by a task control block called Process Control Block (PCB). This block is a big data structure holding different important information associated with a process as shown in figure 1.5. below.

Process state
Process number, PID
Program counter
Registers
Memory limit
List of open files

*Fig. 4.5 : PCB Entries Per Process*

**Process state** : indicate the current status of the process as new, running, waiting, ready.

**Process number** : a unique positive integer value associated with each process during creation and used as an identifier. The getpid() command is used to return the current process's number, PID. In order to read the parent's id, we can use the getppid () command.

**Program counter** : a value indicating the next instruction to be executed for the process

**Registers** : including accumulators, stack pointers, and the like maintains the current value produced when the process runs so that the process resumes from where it left off in case of interrupts.

**Memory limit** : holds the value of the base and limit registers, page table size etc.

#### **4.5 Types of Process :**

**Interactive processes** : Interactive processes are processes which are started by someone connected to the system. They are initialized and controlled through a terminal session not automatically as part of the system functions. These processes can run in the foreground, occupying the terminal that started the program, and other applications cannot be started as long as this process is running in the foreground. Alternatively, the processes can also run in the background, so that the terminal in which you started the program can accept new commands while the program is running. In such a case, the user is also allowed to do other activities in the terminal from which he/she started the program, while it is running. The terminal provides a service called job control that enables simple management to several processes by moving amongst foreground and background processes. With this service, it is also possible to start programs in the background immediately.

**Automatic processes** : Automatic or batch processes are processes that have no linkage to a terminal but are queued into a spooler area, where they wait to be executed on a FIFO (first-in, first-out) basis. Such tasks can be executed using one of two criteria :

At a certain date and time : done using the at command

At times when the total system load is low enough to entertain additional tasks : done using the batch command. By default, tasks are put in a queue where they wait to be executed until the system load is lower than 0.8. In large environments, the system administrator may prefer batch processing when large amounts of data have to be processed or when tasks demanding a lot of system resources have to be executed on an already loaded system. Batch processing is also used for optimizing system performance.

**Daemons :** Daemons are server processes that run continuously. Most of the time, they are initialized at system startup and then wait in the background until their service is required. A typical example is the networking daemon, xinetd, which is started in almost every boot procedure. After the system is booted, the network daemon just sits and waits until a client program, such as an FTP client, needs to connect.

**❑ Check Your Progress – 2 :**

1. The state of a process changes while the process is running (True/False)
2. \_\_\_\_\_ process initialized at system startup and then wait in the background until their service is required  
(a) Interactive (b) Batch (c) Daemons (d) All of these
3. The operating system represents each process by a task control block called  
(a) Program Control Block (b) Process Control Block  
(c) Program Control Bufer (d) Process Control Bufer
4. A process's life cycle comprises of four basic states. (True/False)
5. A unique positive integer value associated with each process during creation and used as an identifier. (True/False)
6. Automatic processes are processes which are started by someone connected to the system. (True/False)

**4.6 Let's Sum Up :**

After a process is created and before it is brought to termination, it assumes different states. A process state determines the current status of the process. There are three different states a process can be in. since only one process is allowed to use the CPU at a time, only that process is in the running state while zero or more processes can be either in the ready or waiting state. A process also moves back and forth between these three different states all the time except no transition is allowed from ready to waiting state. Every process has important information associated and this information are stored in a PCB by the operating system

**4.7 Check Your Progress : Possible Answers :**

**❑ Check Your Progress 1 :**

1. True, 2. (b), 3. (c), 4. False, 5. True, 6. False

**❑ Check Your Progress 2 :**

1. True, 2. (b), 3. (c), 4. False, 5. True, 6. False

**4.8 Assignments :**

- What distinguishes process from program ?
- What three basic reasons cause process creation ?
- How does the system differentiate between processes ?
- What are the different possible states that a process can be in ?
- When does a process move from running to waiting/blocked/sleeping state ?



## **Operating System and Software Installation**

### **4.9 Activity :**

- Open Task Manager in Windows and see the running process and terminate any process by right clicking on it and then click End Task.

### **4.10 Case Study :**

- Explore process scheduling mechanism of Windows Operating System

### **4.11 Further Reading :**

- Andrew S. Tanenbaum (2008). Modern Operating System. 3rd Edition. Prentice-Hall.
- A Silberschatz, Peter B Galvin, G Gagne (2009). Operating System Concepts. 8th Edition. Wiley.

**UNIT STRUCTURE**

- 5.0 Learning Objectives
- 5.1 Introduction
- 5.2 Multithreading
- 5.3 Thread implementation
  - 5.3.1 User Space Thread
  - 5.3.2 Kernel Space Thread
  - 5.3.3 Hybrid Thread implementation
- 5.4 Thread Management
- 5.5 Concurrency and Its Problems
  - 5.5.1 Inter-Process Communication
  - 5.5.2 Concurrency Problem
  - 5.5.3 Mutual Exclusion
- 5.6 Let's Sum up
- 5.7 Check Your Progress : Possible Answers
- 5.8 Assignments
- 5.9 Activity
- 5.10 Case Study
- 5.11 Further Reading

**5.0 Learning Objectives :**

After completing this unit, learner should be able to :

1. Define thread and types of thread implementation
2. Describe concurrency problem
3. Explain Interprocess Communication
4. Define concurency and mutual exclusion

**5.1 Introduction :**

To perform several jobs at a time multiprogramming is a must. A program by itself cannot address several problems at a time. But there is a mechanism through which a program can solve this problem. The answer is thread. What is thread ? How does it work ?

A process is a means through which interrelated resources such as the address space, child processes, opened files, etc. are grouped together. Threads are multiple execution streams within a single process and are used to separate the resource management task of the process from its actual execution. While processes are used to group resources together, threads are the objects scheduled for execution on the CPU. Thread can also be considered as lightweight process

in that it does small portion of the entire task of a process. Having a thread adds an advantage to a process by enabling multiple independent executions in the same process environment by sharing the resources grouped together. The CPU moves back and forth among the threads running and creates an illusion that all of the threads are running in parallel. A process may create several threads (multi-threading) that share same address space and work together to accomplish a job in a sense they are not as such independent as two processes are. Threads are very important in today's programming to handle execution of several tasks of a single process independently of the others. This is mainly true when one of the tasks of the process may block, and it is required to let the remaining tasks run without blocking.

For instance, in a word processor, a thread running in the background may validate spelling and grammar while a foreground thread handles user's input, and yet another third thread fetches images from the local disk, and even a fourth thread is doing periodic automatic backups of the file being edited and so on. Like a single thread (one process), threads can be in any of the states a process can be in that we have discussed in last unit.

## **5.2 Multithreading :**

In a multi-thread model, a process starts by creating only one thread first and the thread creating other threads through a create-thread library procedure call. The newly created thread runs automatically in the address space of the creating thread and the identifier of the newly created thread will be passed to the creating thread. The `exit_thread` library procedure is used to terminate a thread when it finishes its task. A thread can also wait for another thread with a call to the library procedure `thread_wait`. The CPU has no interrupt towards threads, as with processes, that forces them to surrender their usage of the CPU. However, threads use the `thread_yield` procedure call to willingly give up the CPU for other threads to use. This avoids the monopolized usage of the system by a single thread.

Multi-threading brings four main advantages to processes. These are :

- **Responsiveness** : A thread may give results quickly while other threads are waiting or slowed down performing some serious computations.
- **Resource sharing** : By default, threads use common code, data, and other assets, that enables several jobs to be carried out concurrently in one address space.
- **Economy** : Creating, destroying and handling threads is much faster than performing the same operation for processes since no resource is attached to a thread
- **Scalability** : A process with one thread can only run on a single CPU, regardless of the number of CPUs available, while running a process with several threads may require distributing the threads amongst available processors.

Despite these advantages, threads also bring a complication to processes. One problem is associated with the `fork()` system call. Assume a parent and child processes with multi-threading capability. What would happen if a thread in the parent is waiting for input ? Does a thread in the child also get blocked ? Who gets a typed input, only the parent ? The child ? Or both ?

Another problem arose due to the common resources shared among threads. One thread might close or modify a particular resource which is currently being also used by another thread.

In general, since the advantage of multi-threading outweighs its problems, modern computer systems implement the concept of multi-threading but it requires a careful thought and design.

### **5.3 Thread Implementation :**

A system can implement and manage threads through two main ways namely user thread and kernel thread.

#### **5.3.1 User Space Thread :**

The thread packages are placed in their entirety on the user space. These are the threads defined by application software developers during application creation with the kernel having no knowledge about them and it operates as if a single-threaded process is being managed. This is a good mechanism to implement threads on operating systems that does not support one.

The thread archive also has codes to be used for threads creation and deletion, for transferring messages and data amongst threads, for scheduling thread execution and also for storing and reinstating thread contexts. The application software starts with one thread and its execution begins in that thread. Each process defines a separate thread table which is then controlled by a run-time system to maintain information related to each thread in the process. Whenever a thread would like to move from one state to another, a run-time system procedure is called that checks the validity of the change and stores the current values in the thread's registers into the thread table so that the thread will resume later on from where it has stopped.

Invoking the run-time system procedures is way effective than performing a kernel call as no trap and no context switch is needed and also as it does not require to flush the memory cache making thread scheduling very fast. Such type of thread implementation also allows processes to have their own customized scheduling algorithm. Scalability is again another advantage of user space thread implementation as several threads can be defined and implemented easily. User space thread implementation has also its own drawbacks.

One problem is in relation to page fault. System can be set not to load a program in its entirety onto main memory at once. A page fault occurs when a process looks for instructions not loaded in memory. During such cases, the process is blocked until the operating system finds and reads the required instruction from disk. If a thread makes a page fault to happen, the kernel will block the entire process until the missing request is being processed as it is unaware of the multi-threaded implementation of the process and deprive other runnable threads from running.

The second problem associated with user space thread implementation is that a single thread can monopolize the time slice and make starve the other threads within the process unless it willingly returns the CPU. Since clock interruption is not found within a single process round-robin scheduling is impossible and also making it impossible for the scheduler to interrupt unless a thread enters the runtime system of its own free will. There are cases where absence of clock interrupts is very important like during synchronization. Especially, it is common in distributed systems for one thread to start a job

that requires reply of another thread and then waits in a busy loop checking if the response has happened.

This situation is called a spin lock or busy waiting. A spin lock is important especially when the response is needed immediately and the cost of using semaphores is high. If threads are suspended automatically every few milliseconds using a clock interrupts, this approach works fine. However, if threads are allowed to execute until they block, this situation is an input for deadlock. Figure 5.1 depicts user space thread implementation.

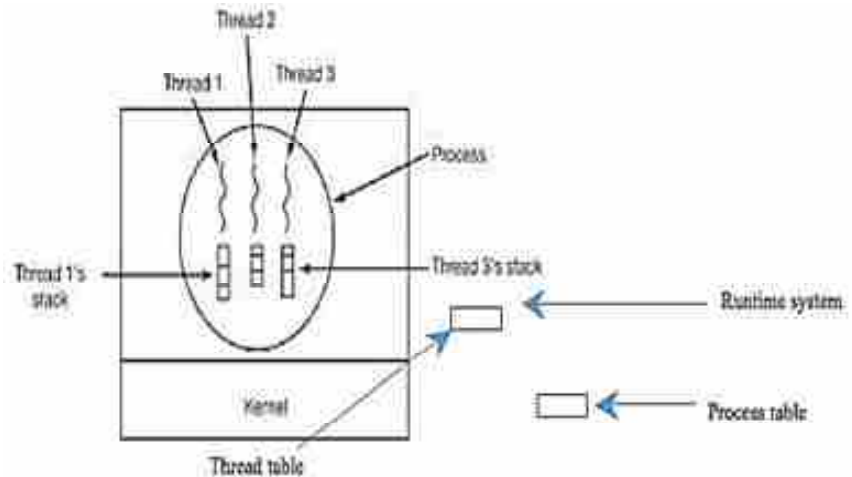

**Fig. 5.1 : User Space Thread Implementation**

### 5.3.2 Kernel Space Thread :

Kernel is aware of available threads and manages the threads. All modern operating systems provide kernel level threads, enabling the kernel to carry out several concurrent jobs and/or to run multiple kernel system calls at a time. Rather than defining separate thread tables in every process, the kernel maintains a single thread table with similar attributes as the process's thread table for all the threads found in the system. The kernel also has a process table to maintain the existing processes. Whenever a thread is blocked through system calls, the kernel can run either a ready thread from same process or another process.

Thread creation and destroy has larger costs in this kernel mode. To minimize this cost, some systems implement thread recycling. In this case, a thread destroyed will be deactivated without affecting its data structures and when a new thread is created, the deactivated thread will be brought back to life. In Kernel threads there is no need to define new non-blocking system calls and if a thread has encountered a page fault, the kernel will check for another ready thread in a process and allow this thread to run until the page fault is resolved.

The main difference between a kernel thread and a user thread is the fact that the kernel thread has no user task memory mapping. Like other user processes, it shares the kernel address space but the thread operates only in kernel space with kernel privileges. Because kernel has full knowledge of all threads, Scheduler may allocate more execution time to a process with large number of threads than processes having small number of threads. Kernel-level threads are mainly useful for processes that frequently block. However, kernel-level threads are known to be slow and inefficient. Threads operations in kernel-level are hundreds of times slower than that of user-level threads. Since kernel

has to control and schedule threads as well as processes, the kernel needs to keep information of each thread through a full thread control block. As a result, there is substantial overhead, substantial cost to system calls and increased complexity in kernel. Figure 5.2. Depicts the kernel level thread implementation

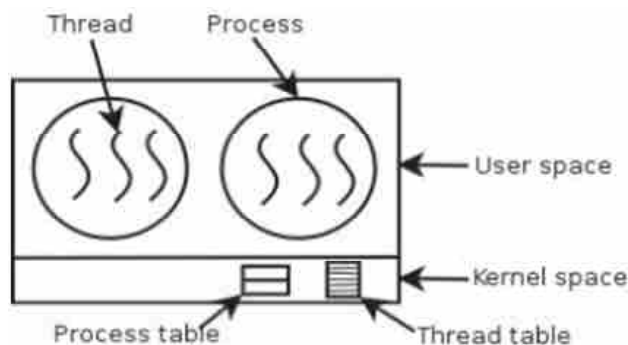

**Fig. 5.2 Kernel Thread Implementation**

### **5.3.3 Hybrid Thread Implementation :**

Combining the advantages of both the user space thread implementation and the kernel level thread implementation can be more effective than using them individually. Different techniques had been explored on how to bring together the benefits of user-level threads to that of kernel-level threads. Using kernel level threads and multiplexing user level threads onto all or some of the kernel threads is one way identified. In this method the kernel knows only about the kernel level threads, which might have zero or more multiplexed user-space threads that take turns using it, and handles scheduling of those threads.

Another approach is the so-called scheduler activation that imitates the services of kernel level threads, but with improved efficiency and better flexibility usually related with thread packages implemented in user space. In this technique, the kernel allocates some number of logical processors to every process and allows the user-space run-time system assign threads to processors. Initially, the kernel will assign a single virtual processor to each process but processes can also demand for additional and can also give back if no longer needed. It is also possible for the kernel to take back an already given virtual processors and re-allocate them to other, more needy, processes. The kernel activates the user space run time system through an up call in order to notify about an event happening on threads. For instance, when the kernel is aware of a thread just moved to its blocked state, it will immediately notify the run time system by putting the code of the thread identified along with a report of the event happened on to the stack.

With this knowledge, the runtime system tries to reschedule the threads according to their states. A hardware interrupt may occur while a user thread is being executed where the interrupted virtual CPU moves to a kernel mode and manages the interrupt. If the interrupt occurred has no significance to the interrupted thread, it will be returned back in its state before the interruption. If, on the other hand, the thread has some interest towards the interrupt, it will be suspended and the runtime system will be up called with the state of this thread passed onto the stack. The runtime system then decides which thread to grant the CPU for : the interrupted thread, a new thread which is in its ready state, or some other third choice.

## **5.4 Thread Management :**

Pthreads are Linux implementation of thread management mechanism. Pthreads are defined as a set of C language programming types and procedure calls. Vendors usually provide a Pthreads implementation in the form of a header/include file and a library, which you link with your program. The two names used in thread management frequently are : pthread\_t for thread objects and pthread\_attr for thread attributes objects.

The pthread\_create function is used to create a new thread, and pthread\_exit function for terminating a thread by itself. A thread to wait for termination of another thread uses the function pthread\_join.

Normally when a program starts up and becomes a process, it starts with a default thread which brings the conclusion that every process has at least one thread of control. A process can create extra threads using the following function :

```
#include <pthread.h>
int pthread_create (pthread_t *restrict tidp, const pthread_attr_t
*restrict attr, void *(*start_rtn) (void), void *restrict arg)
```

Where :

- The first argument is a pthread\_t type address. Once the function is called successfully, the variable whose address is passed as first argument will hold the thread ID of the newly created thread.
- The second argument may contain certain attributes which we want the new thread to contain. It could be priority etc.
- The third argument is a function pointer. This is something to keep in mind that each thread starts with a function and that functions address is passed here as the third argument so that the kernel knows which function to start the thread from.
- As the function may accept some arguments also we can pass these arguments in form of a pointer to a void type, which is the fourth argument.

### **□ Check Your Progress – 1 :**

1. Thread can also be considered as heavyweight process (True/False)
2. A process may create \_\_\_\_\_ threads  
(a) One            (b) Two            (c) Three            (d) Many
3. Which of the following is an advantage of Multi-threading to process ?  
(a) Responsiveness            (b) Economy  
(c) Scalability            (d) All of these
4. A system can implement and manage threads through two main ways namely user thread and kernel thread. (True/False)
5. Thread creation and destroy has smaller costs in this kernel mode.  
(True/False)
3. The main difference between a kernel thread and a user thread is the fact that the kernel thread has no user task memory mapping. (True/False)

## **5.5 Concurrency and Its Problems :**

The most fundamental task of modern operating systems is management of multiple processes within uniprocessor, multiprocessor or distributed computer systems. The fundamental design issue in the management of multiple processes is concurrency : simultaneous execution of multiple processes

**Concurrency arises in three different contexts**

**Multiple applications :** concurrently running applications

**Structured applications :** an application structured as a set of concurrent processes (threads)

**OS structure :** OS implemented as a set of processes

Concurrency provides major benefits in processing efficiency and in program structuring

### **5.5.1 Inter-Process Communication :**

There is frequent interaction among concurrently running processes. There are three ways in which concurrent processes interact with each other :

#### **❖ Competition for Resources :**

- It occurs when independent processes that are not intended to work together compete for the use of the same or shared resource, e.g. printer, memory, or file.
- No communication or message exchange exists amongst such competing processes.
- Processes are unaware of the existence of each other

#### **❖ Cooperation by Sharing Resources :**

- It occurs when processes that are not necessarily aware of each other usage and interaction to shared data without reference to other processes but suspects that other processes may have access to the same data
- Processes need to collaborate and guarantee that the data they share are properly managed Processes are aware of the existence of each other indirectly

#### **❖ Cooperation by Communication :**

- It occurs when various processes communicate with each other, for instance with message passing in order to provide a way to synchronize or coordinate their various activities.
- There is nothing shared between processes
- Processes are aware of the existence of each other directly

### **5.5.2 Concurrency Problems :**

There are some serious problems associated with the interaction of concurrently running processes :

**Race Condition :** A situation that occurs when two or more processes are reading or writing into some shared data and the final result depends on who runs precisely.

**Deadlock :** It is the permanent blocking of a set of processes that either compete for system resources or communicate with each other. It involves conflicting needs for resources by two or more processes.



## Operating System and Software Installation

It refers to a situation in which a set of two or more processes are waiting for other members of the set to complete an operation in order to proceed, but none of the members is able to proceed.

e.g. Traffic deadlock : consider a situation in which four cars have arrived at a four-way stop intersection at the same time. The four quadrants of the intersection are the resources over which control is needed. If all four cars proceed into the intersection, then each car controls one resource (one quadrant) but cannot proceed because the required second resource has already been controlled by another car. Hence deadlock will occur. The main reason for this deadlock is because each car needs exclusive use of both resources for certain period of time.

It is a difficult phenomenon to anticipate and there are no easy general solutions to this problem.

**Starvation** : It referees to the situation in which a process is ready to execute but is continuously denied access to a processor in deference to other processes.

e.g. suppose that there are three processes P1, P2, and P3 and each require periodic access to resource R. If the operating system grants the resource to P1 and P2 alternately, P3 may indefinitely be denied access to the resource, thus starvation may occur.

### 5.5.3 Mutual Exclusion :

The key to preventing race condition is to enforce mutual exclusion : It is the ability to exclude (prohibit) all other processes from using a shared variable or file while one process is using it.

Part of a program where shared resource (critical resource) is accessed is called critical region or critical section.

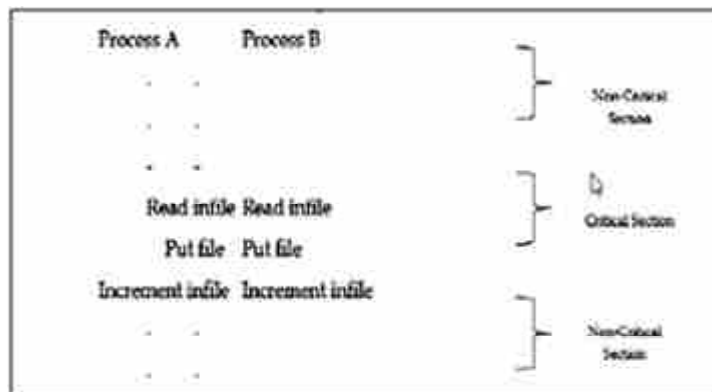

**Fig. 5.3 : Critical Section**

The fundamental strategy for implementing mutual exclusion is avoiding the situation where no two processes could ever be in their critical regions at the same time.

There are some basic requirements that should be met while implementing mutual exclusion

- No two processes may be simultaneously in their critical regions
- No assumptions may be made about speed or the number of processors
- No process running outside its critical region may block other processes
- No process should have to wait forever to enter its critical region

**❑ Check Your Progress – 2 :**

1. Dependency exists between threads and they work collaboratively to accomplish a task and also share same resources. (True/False)
2. The fundamental design issue in the management of multiple processes is\_\_\_\_\_  
(a) Integrity (b) Concurrency (c) Threading (d) None of these
3. Thread is a basic unit of CPU utilization, consisting of \_\_\_\_\_  
(a) A program counter (b) A stack  
(c) Thread ID (d) All of these
4. There are three ways in which concurrent processes interact with each other (True/False)
5. Race condition is the permanent blocking of a set of processes that either compete for system resources or communicate with each other.  
(True/False)
6. \_\_\_\_ is a situation in which a process is ready to execute but is continuously denied access to a processor in deference to other processes.  
(a) Race Condition (b) Deadlock  
(c) Starvation (d) None of these

**5.6 Let's Sum Up :**

Thread is a basic unit of CPU utilization, consisting of a program counter, a stack, a set of registers, and a thread ID. A process can have one or more threads which share the same resources like the address space and opened files of a process. Threads differ from processes in that dependency exists between threads and also they work collaboratively to accomplish a task and also share same resources. Threads have also similarity with processes as they have a unique thread ID similar with PID, threads can also be in any of the process states, threads can create child threads, etc.

Concurrently running processes compete for resources. These processes might communicate directly through message or share common variable on the memory. Concurrency have associated problems, namely race condition, starvation and deadlock. To avoid race condition, mutual exclusion is a solution. This unit addressed implementation of mutual exclusion using number of techniques from busy waiting and non-busy waiting approaches.

**5.7 Check Your Progress : Possible Answers :****❑ Check Your Progress 1 :**

1. False, 2. (b), 3. (c), 4. True, 5. False, 6. True

**❑ Check Your Progress 2 :**

1. True, 2. (b), 3. (c), 4. True, 5. False, 6. (e)

**5.8 Assignments :**

1. What is the importance of using threads ?
2. What are the main differences between user space and kernel threads ?
3. What are the disadvantages of kernel level thread implementation ?

4. Which problems of user space thread implementation are solved by using the scheduler activation thread implementation method ?

**5.9 Activity :**

- Use windows task manager to manage process

**5.10 Case Study :**

- Study thread management in windows operating system

**5.11 Further Reading :**

- Andrew S. Tanenbaum (2008). Modern Operating System. 3rd edition. Prentice– Hall.
- A Silberschatz, Peter B Galvin, G Gagne (2009). Operating System Concepts. 8th Edition. Wiley.
- William Stallings (2005). Operating Systems Internals and Design Principles. 4th edition. Prentice Hall.

**UNIT STRUCTURE**

- 6.0 Learning Objectives
- 6.1 Introduction
- 6.2 Overview of Process Scheduling
- 6.3 Scheduler
  - 6.8.1 Long-Term Scheduler
  - 6.8.2 Short-term scheduler
- 6.4 Scheduling
- 6.5 Process scheduling policies
  - 6.8.1 Non Preemptive scheduling
  - 6.8.2 Pre-emptive scheduling
- 6.6 Context switch and the interrupt handler
- 6.7 Scheduling criteria
- 6.8 Scheduling Algorithms
  - 6.8.1 First-Come First-Served (FCFS) Scheduling
  - 6.8.2 Shortest Job First (SJF) Scheduling
  - 6.8.3 Shortest Remaining Time Scheduling
  - 6.8.4 Round Robin Scheduling (RR)
  - 6.8.5 Priority Scheduling
  - 6.8.6 Multilevel Queue Scheduling
  - 6.8.7 Thread Scheduling
  - 6.8.8 Multiple Processor Scheduling
- 6.9 Let's Sum Up
- 6.10 Check Your Progress : Possible Answers
- 6.11 Assignments
- 6.12 Activities
- 6.13 Case Study
- 6.14 Further Reading

**6.0 Learning Objectives :**

After completing this unit, learner should be able to :

1. Define scheduling, scheduler and types of scheduler
2. Describe process scheduling policies
3. Explain types of scheduling algorithms
4. Define CPU burst, context switch and interrupt handler

## **6.1 Introduction :**

Starvation is one of the problems of concurrency. In a multiprogramming environment, processes compute for the uniprocessor. How does the operating system execute these processes in turn with minimal starvation ?

Kernel is one part of an operating system that carries out several activities and operations among which process management is one. The process management task includes handling process creation, termination, inter-process communication, scheduling, switching, dispatching and management of process control blocks. Scheduling is a means through which fair distribution of execution time is granted to processes with similar state for a multiprogramming system. Multiprogramming aims to have some process running at all times and maximize CPU utilization by switching the CPU among processes so frequently that users can interact with each program while it is running.

## **6.2 Overview of Process Scheduling :**

The two main objectives of the process scheduling are to keep the CPU busy at all times and to deliver "acceptable" response times for all programs, particularly for interactive ones. The process scheduler must meet these objectives by implementing suitable policies for swapping processes in and out of the CPU. The idea behind multiprogramming is to execute a process until it changes its state to waiting, typically for the completion of some I/O request and use this time productively rather than making the CPU idle until the process comes back to its ready state again. To accomplish this, several processes are kept in memory at one time and when one process has to wait, the operating system takes the CPU away from that process and grants to another process. This pattern continues.

However, there is a frequent chance for more than one process to be in a ready state at the same time which forces them to compete for the CPU. The system should then make a wise choice as to which process to run next. Component of the operating system with the responsibility of choosing a process to run is known as scheduler and the steps it follows scheduling algorithm. The task of the scheduler is, thus, to decide on a policy about which process to be dispatched, select a process according to the scheduling algorithm chosen and load the process state or dispatches the process for execution. Scheduling is a means by which process migration between the three different queues maintained by a multiprogramming system can be achieved.

These three different queues of processes are :

- **Job queue** : set of all processes found in the system.
- **Ready queue** : set of all processes residing in main memory, ready and waiting to execute.
- **Device queue** : set of processes waiting for a particular I/O device.

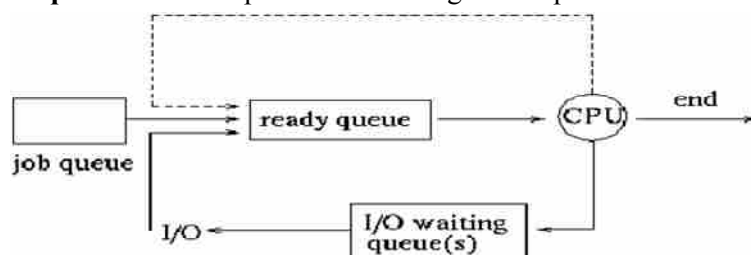

*Fig. 6.1 : The three processes queue and CPU interaction among them*

### 6.3 Scheduler :

There are two kinds of schedulers in a system : Long-term scheduler (job scheduler) and Short-term scheduler (CPU scheduler).

#### 6.3.1 Long-Term Scheduler

Long-term scheduler selects processes from job queue and loads the selected process into memory for execution and then updates the ready queue. This scheduler also manages the number of processes in memory that entitles it in control of the multiprogramming degree within a system. A good mix of CPU-bound and I/O bound processes should be maintained in memory by this scheduler to make the system more efficient. This scheduler is invoked very infrequently and thus can be slower when it comes to performance. Such type of schedulers may not be present in some systems like time sharing ones.

#### 6.3.2 Short-Term Scheduler :

Decides which process to execute next and allocates the CPU. It picks processes found in the ready queue and dispatches them for execution by the CPU. This scheduler is also known as the dispatcher and invoked very frequently which makes it to be extremely fast. As the CPU is one of the primary computer resources, its scheduling is central to operating system design.

### 6.4 Scheduling :

Scheduling is fundamental to operating system function. Almost all computer resources are scheduled before use. The scheduler will not have that much of a task on simple multi-programmed PCs as only one program is actually running currently and the user also waits for the completion of all programs. When it comes to high-end networked workstations and servers, the scheduler has a real job here and scheduling algorithms used significantly affects the efficient use of the system. When does a system need to schedule is a question that should be addressed before going deep into the scheduling process ?

Four different events bring the need for scheduling. These are :

**State change from running to waiting :** The current process goes from the running to the waiting state because it issues an I/O request or some operating system request that cannot be satisfied immediately.

**State change from running to ready :** For instance, a timer interrupt causes the scheduler to run and decide that a process has run for its allotted interval of time and it is time to move it from the running to the ready state.

**State change from waiting to ready :** For instance, an I/O operation is complete for a process that requested it and the process now moves from the waiting to the ready state. The scheduler may then decide to preempt the currently-running process and move this ready process into the running state.

**Terminates :** Some processes spend more time in a waiting state as they have more I/O requests while some processes spend more time in their running state. The period of computation between I/O requests of a process is called the CPU burst. In general, processes can be described as I/O bound or CPU bound. An I/O-bound process is one that spends more of its time doing and waiting for I/O than it spends doing computations. Such type of processes generally experiences short CPU bursts. A CPU-bound process, in contrast,

generates I/O requests infrequently, using more of its time doing computations and exhibit long CPU bursts. It is important that the job scheduler selects a good process mix of I/O-bound and CPU-bound processes for best performance.

## **6.5 Process Scheduling Policies :**

There are two types of process scheduling policies that can be used by the scheduler. These are : pre-emptive scheduling algorithm and non-pre-emptive scheduling algorithm. We will discuss one by one.

### **6.5.1 Non Preemptive Scheduling**

If the scheduler cannot take the CPU away from a process, it is referred as non-pre-emptive or cooperative scheduler. Such types of scheduling run a process to completion and there will not be any scheduling choice to be made. The process itself releases the CPU for other processes willingly by terminating or by moving to a waiting state. In both cases, a software interrupt is issued which in turn switches the CPU over to start running the scheduler. The scheduler can now decide the next process to be run on the CPU. A non-pre-emptive or cooperative scheduling is a way in which processes will not be asked to give up the CPU unless they terminate or change their state to waiting. Older versions of Macintosh operating system and Windows 3.x are examples that had used the non-pre-emptive scheduling method.

### **6.5.2 Preemptive Scheduling :**

A preemptive scheduler has the ability to get invoked by an interrupt and move a process out of a running state and let another process run. a special hardware device called an interval timer is designed to produce a hardware interrupt on a periodical basis (known as a time slice) and when this interrupt is received by the CPU, it will switch over to start running the scheduler, which will in turn decide on a new process to be run on the CPU. Such types of scheduling algorithms make interruption to distribute the CPU fairly among processes. A process is allowed to run only for some fixed amount of time and when the time is over, another process from the ready list will be picked and granted the CPU.

Pre-emptive scheduling has two main drawbacks, the extra cost incurred while accessing shared data and the complexity it adds on the kernel of the operating system. Note that in both cases, the scheduler will be activated upon reception of an interrupt. For non preemptive scheduling, the interrupt is a software interrupt issued by the process, whereas in preemptive scheduling, the interrupt is a hardware interrupt issued by an external hardware device or it can also be a software interrupt (through an I/O operation) issued by a process which will activate the scheduler in the same way as in non-preemptive scheduling.

## **6.6 Context Switch and The Interrupt Handler :**

Whenever the CPU switches from executing one process to executing another process, a context switch is said to take place. Context switching requires saving of information for the processes so that execution can recommence at the right place. For example, assume you are arguing with your friend about the benefits of learning Operating System instead of Computer Maintenance (or vice versa, of course!) and you are rudely interrupted by another friend who insists on having an urgent discussion about a project. After you have

finished your discussion about the project, you return to your first friend. At this stage, in order to be able to resume the conversation at exactly the point you left off at, you will need to remember what you were talking about, the stage of the argument you were at and all the points that you have presented so far. If you had not previously 'saved' this information, you would have to restart the conversation from scratch, hardly an appealing consideration for your friend. This same analogy should be performed by the CPU every time one process' execution is interrupted and another process gets the privilege.

Assume that the CPU is currently executing instruction 4 of process A, and for some reason, a switch is made to process B. If execution is to be resumed at A, then we will need to know the next instruction to be executed (presumably instruction 5). Thus, the contents of the PC and other registers as well must be saved in the PCB for process A. After all the saving is done, the CPU is now ready to execute process B. In order to do this, it will need to know the next instruction to execute in process B and store the address of this instruction in the PC which can be found in the PCB of process B. In effect, during a single context switch, we need to first save the context of the current process that is going to be suspended and then restore the context of the new process that the CPU is going to switch to. This entire context saving and restoring is done by a special program called the interrupt handler that is part of the process management component of the OS. Saving and restoring information by the interrupt handler is a time-consuming operation and represents wasted time as far as the CPU is concerned.

This is because the CPU is only considered to be doing something useful when it is executing instructions that belong to a user process (either process A or B in the previous example). During a context switch, the CPU is actually executing the interrupt handler which handles the saving and restoring of information contained in the individual PCBs. The more context switches there are between processes, the more time is wasted running the interrupt handler (instead of running the processes) and the less efficient the CPU will be. This is an important consideration especially when it comes to preemptive scheduling.

### **6.7 Scheduling Criteria :**

Different schedulers aim to achieve different goals like minimizing latency, maximizing throughput or maximize process utilization, etc. Some properties are needed by all systems while some depend on the implementation environment due to a variant in the specific requirements of the various application areas as well as different operating systems. In a batch operating system, for instance, time is an insignificant attribute to be considered by the scheduler as users are not looking for instant response from the system. As a result, non-preemptive or preemptive with long time for each process scheduling algorithms can be used by the scheduler enhancing the system's performance through less process switching. On the other hand, in a real time environment, where processes are aware of giving up the CPU so quickly to one another, light preemptive scheduling algorithm is enough. For interactive systems, however, restricted preemptive scheduling algorithm is needed to avoid depriving CPU among processes. Some of the common criteria different schedulers considering a scheduling algorithm are the following.

**Fairness :** all processes should be able to use the CPU fairly, especially comparable processes. Fairness is a way in which the scheduler tries to allocate



CPU for comparable processes at comparable rate so that equitable access to resources is granted. Sometimes, however, fairness is at odds with other scheduling criteria. For instance, throughput and response time of a system can be enhanced by making it less fair.

**System utilization :** the CPU as well as I/O devices of the system should always be kept busy. Keeping them execute all the time implies more operation performed per second. The scheduler needs to keep a mixture of CPU and I/O bound processes in memory to avoid idleness in all components of the system. In real systems, this ranges from 40% to 90% utilization.

**Throughput :** is the number of tasks completed by a system per time unit. Ideally, a system is required to finish as many processes as possible though the actual number depends upon the lengths of the processes. Throughput should be maximized by minimizing overheads and efficiently using systems' resources.

**Turnaround time :** The time gap between arrivals of a process to its completion. It is the sum of the periods spent waiting to get into memory, waiting in the ready queue, executing on the CPU, and doing I/O. It predicts for how long an average user needs to wait for a response from the system. Generally, a process is expected to take minimal time from its creation to termination.

**Response time :** is the time elapsed to get the result of a submitted command. It is the amount of time it takes from when a request was submitted until the first response is produced, not output. This is very crucial especially for interactive and real time systems.

Ideally, a scheduling algorithm needs to maximize resource utilization and throughput while minimizing turnaround time and response time.

❑ **Check Your Progress – 1 :**

1. Kernel carries out process management is one. (True/False)
2. Set of all processes residing in main memory, ready and waiting to execute resides in \_\_\_\_\_ queue.  
(a) Job                      (b) Ready                      (c) Device                      (d) None of these
3. If the scheduler cannot take the CPU away from a process, it is referred as\_\_\_\_\_  
(a) Non-pre-emptive                      (b) Pre-emptive  
(c) (a) or (b)                      (d) None of these
4. Turnaround time is the time elapsed to get the result of a submitted command. (True/False)
5. Throughput is the number of tasks completed by a system per time unit.  
(True/ False)
6. Ideally, a scheduling algorithm needs to maximize resource utilization and throughput while minimizing turnaround time and response time.  
(True/False)

**6.8 Scheduling Algorithms :**

In this setion we will discuss different types of scheduling algorithm such as First-Come First-Served (FCFS), Shortest Job First (SJF), Shortest Remaining Time, Round Robin (RR), Priority based, Multilevel Queue, Thread and Multiple Processor Scheduling.

**6.8.1 First–Come First–Served (FCFS) Scheduling :**

This is the simplest non–pre–emptive scheduling algorithm whereby the CPU executes processes that arrived earliest. In this algorithm, processes are dispatched according to their arrival time. There is one FIFO queue for ready state processes. When the first process comes to the system, it will be started immediately and run till it finishes all its jobs or till it needs to. If other jobs have arrived during execution of the first process, they will be lined up in the ready queue and will get a chance to run sequentially when the first process terminates or blocks. When a blocked process changes its state to ready, it will be treated like a new one and put at the end of the queue. The main advantage of this algorithm is its simplicity to implement.

A single linked list needs to be created and every time the system is free, the front child will be removed from the list and every time new process is added to the ready state or a blocked process has moved to its ready state, a new node is added at the end of the list. However, FCFS scheduling comes with a severe problem which is poor waiting and turnaround time for processes. Consider three processes P1, P2, and P3 submitted to the ready queue in this sequence and assume the processes have a burst time of 24, 3, and 3 respectively. Process P1 will run automatically as there is no other process ahead of it in the queue which makes the waiting time of it 0. Waiting time of P2 is 24 as it goes after P1 has completed.

Waiting time for P3 will be 27 (P1 run time + P2 runtime) as shown in figure 6.1 below and the average waiting time becomes 17  $[(0 + 24 + 27)/3]$ . The average completion time for the three process also become 27  $[(24 + 27 + 30)/3]$ . This shows that for processes with long runtime being in front of the queue, short jobs get stuck behind and makes the waiting time very long reducing the performance of these processes. Such types of scheduling algorithms are also not suitable for interactive systems.



*Fig. 6.2 : FCFS Process Execution*

**6.8.2 Shortest Job First (SJF) Scheduling :**

This is another non–preemptive scheduling algorithm that handles jobs based on the length of time that the CPU requires to process them. When there are several equally important jobs queued in the ready queue waiting to be started, the scheduler picks the process with the shortest execution time requirement first. Moving a short job before a long one decreases the waiting time for short job more than it increases the waiting time for the longer process. SJF scheduling prefers I/O bound processes because running short CPU–burst jobs first gets them done and moves them out of the way and it also enables to overlap their I/O request which enhances the efficiency of the CPU. This algorithm is actually taken from the "procrastination" behavior of human beings. When faced with too much work, we prefer to do the short tasks first and get them out of the way leaving the big, hard tasks for later.

This algorithm is efficient only if it is possible to predict in advance the amount of CPU time required by each job which is possible for batch environments, but difficult for interactive systems. If two processes have the same length next CPU burst, FCFS scheduling is used to break the tie.

Consider the previous three processes P1, P2 and P3 with same CPU time and similar sequence. Now using SJF, P2 will be executed first followed by P3 and at last P1 if they arrived simultaneously.



**Fig. 6.3 : Sample Arrangement of Process in SJF Scheduling**

As you can observe on the figure, waiting time for P2 has become 0, for P3 to be 3 and for P1 6 reducing the average waiting time from 17 (FCFS) to 3 and the average completion time 13  $[(3 + 6 + 30)/3]$  from 27. However, it is worth to note that SJF is optimal only for simultaneously available jobs.

### **6.8.3 Shortest Remaining Time Scheduling :**

This is a pre-emptive variant of the SJF scheduling algorithm which preempt the currently running job if a newly arriving job has shorter expected CPU burst time. It operates by comparing the time left for completion of the running process with the total execution time of a new process. The scheduler immediately stops the running process and gives higher priority to the newly arriving process if and only if its execution time is smaller than remaining completion time of the running one. Again, in this algorithm, the runtime of a process needs to be known in advance. The advantage of SRT scheduling algorithm is the optimal average response time resulted and the reduced waiting time especially for short jobs. However, larger jobs might be deprived of the CPU and end up in starvation if several small jobs arrive.

### **6.8.4 Round Robin Scheduling (RR) :**

This scheduling algorithm is known to be the simplest, fair and most widely used scheduling algorithm most suitable for interactive systems. It assigns time slices to each process in equal portions and in circular order, handling all processes without priority. Round-robin scheduling can also be applied to other scheduling problems, such as data packet scheduling in computer networks. The name of the algorithm comes from the round-robin principle known from other fields, where each person takes an equal share of something in turn. It is similar to FCFS scheduling, but preemption is added to switch between processes. A small unit of time, called a time quantum (or time slice), is defined which is generally from 10 – 100 milliseconds. The ready queue is treated as a circular queue. The scheduler goes around the ready queue, allocating the CPU to each process for a time interval of up to 1-time quantum. No process is allocated the CPU for more than 1-time quantum in a row. If a process' CPU burst exceeds 1-time quantum, that process is preempted and is put back in the ready queue.

To implement the RR scheduling, we keep the ready queue as a FIFO queue of processes. New processes are added to the tail of the queue. The CPU scheduler picks from the head of the queue, sets a timer to interrupt after 1-time quantum, and dispatches the process. One of two things will then happen. The process may have a CPU burst of less than one-time quantum in which case the process itself releases the CPU voluntarily and the scheduler will then proceed to the next process in the ready queue. Otherwise, if the CPU burst of the currently running process is longer than 1-time quantum, the timer will go off and will cause an interrupt to the operating system. A

context switch will be executed, and the process will be put at the tail of the ready queue. The scheduler then selects the next process in the ready queue. It is important to note that the length of the quantum time determines the efficiency of the algorithm as well as the turnaround time. If the quantum time is too large, RR becomes a mere copy of FCFS scheduling algorithm and results in poor response for small interactive jobs. If too small is the quantum time, it results in several switches between processes increasing the average turnaround time and reduce the efficiency of CPU. A quantum around 20–50msec can be a reasonable compromise.

**Example :** Consider four processes P1, P2, P3 and P4 arrived at time 0 with CPU–burst time of 53, 8, 68, and 24 msec respectively. Using the RR scheduling algorithm with 20msec quantum time, the processes will be executed in the sequence shown in the following chart below

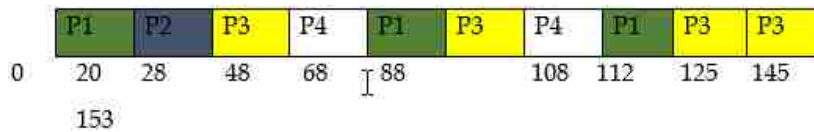

$$\text{Waiting time for P1} = (68 - 20) + (112 - 88) = 72$$

$$P2 = (20 - 0) = 20$$

$$P3 = (28 - 0) + (88 - 48) + (125 - 108) = 85$$

$$P4 = (48 - 0) + (108 - 68) = 88$$

$$\text{Average waiting time} = (72 + 20 + 85 + 88)/4 = 66\frac{1}{4}$$

### 6.8.5 Priority Scheduling :

In a multiprogramming system, processes can be given different rank taking into consideration behaviors of the processes or other system defined or user defined criteria. For instance, a daemon process transferring email in the background should have less priority than a foreground process outputting video to the visual display in real time. A priority scheduling algorithm works by allocating the CPU for processes with highest priority value. Each process in a job queue is assigned a priority value according to its importance and urgency, the scheduler then allocates CPU to the processes according to their priority level. Again, note that for processes with similar priority value, FCFS scheduling algorithm is used.

Priority is expressed in terms of fixed range number such as 0 to 10. However, there is no general agreement on whether 0 is the highest or lowest priority. Some systems use low numbers to represent low priority while others use low numbers for high priority. But in this module, we will use low numbers to represent high priority.

Priority scheduling works as preemptive as well as nonpreemptive policy. The priority of a newly arriving process into a ready queue is compared with that of the currently running process. A preemptive priority–scheduling algorithm will preempt the CPU if the priority of the newly arrived process is higher than that of the currently running process. A nonpreemptive priority–scheduling algorithm, on the other hand, will simply put the new process at the head of the ready queue and waits for the running process to give the CPU voluntarily and run the arrived process then after.

Processes can be given priority statically or dynamically. In a static priority, process is assigned a fixed priority value according to some external

criteria such as importance of the process, owner of the process, or any other factor which is not part of the operating system. In such cases, the priority will not be adjusted dynamically. In dynamic allocation of priority, the system uses some measurable quantities or qualities including time limits, memory requirements, file requirements and CPU or I/O requirements to compute priority of a process and accomplish a certain system goals. For example, a process with high I/O bound time, high priority will be given and CPU is granted immediately to avoid memory occupation for unnecessarily long time.

**Example :** Consider list of processes with arrival time, burst time and priority level as given in the following table below

<i>Process</i>	<i>Arrival</i>	<i>CPU–Burst time</i>	<i>Priority</i>
<i>P1</i>	<i>0</i>	<i>3</i>	<i>2</i>
<i>P2</i>	<i>1</i>	<i>2</i>	<i>1</i>
<i>P3</i>	<i>2</i>	<i>1</i>	<i>3</i>

- **At time, 0 sec :** Only P1 has arrived to the ready queue with Burst Time 3 and Priority 2. So, CPU will start P1 and do 1 second job of P1.
- **At time, 1 sec :** Now the processes become two; P1 that arrived at 0sec and P2 arrived at 1sec. since priority of P2 is higher than that of P1, P2 will get a chance to use the CPU and will run for 1sec.
- **At time, 2 sec :** Now there are 3 jobs; P1 that arrived at 0sec and has 2 sec job to be done with Priority 2, P2 that arrived at 1 sec and has 1 sec job to be done with Priority 1 and P3 that arrived at 2 sec and has 1 sec job to be done with Priority 3. Here, P2 is with the highest priority, thus CPU will do 1 sec remaining job of P2 which brings the process to completion.
- **At time, 3 sec :** Two processes are left, P1 and P3 with 2 and 3 priority levels respectively. P1 will be thus, executed to completion till 5 sec.
- **At time, 5 sec :** There is only 1 job left by now, that is P3 with burst time 1 and priority 3. So, CPU will do 1sec job of P3 bringing it to completion. This whole activity can be shown in a time–line as shown below

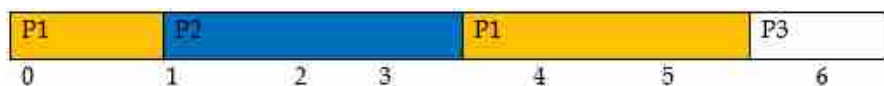

The average waiting time can be computed as :

$$(P1's \text{ Waiting Time} + P2's \text{ Waiting Time} + P3's \text{ Waiting Time})/3 = (2 + 0 + 3)/3 = 1.7\text{sec}$$

It is also possible to group processes into a priority class and use the priority scheduling among the groups while RR or other scheduling algorithm can be used for the processes inside a class. A major problem with priority scheduling is indefinite blocking or starvation of processes with the least priority value. Low priority processes indefinitely wait for the CPU because of a steady stream of higher–priority processes. Aging can be used as a solution towards this problem.

Aging is a technique of gradually increasing the priority of processes that wait in the system for a long period of time.

### 6.8.6 Multilevel Queue Scheduling :

This scheduling algorithm uses the best of each algorithm by having more than one queue and is used for situations in which processes can easily be classified into different groups. For example, a common division is made between foreground (interactive) processes and background (batch) processes. These two types of processes have different response-time requirements and so may have different scheduling needs. Ready queue is partitioned into several separate queues and processes will be permanently placed in these queues based on some criteria. Each queue then implements its own scheduling algorithm for the processes inside and commonly a static preemptive scheduling algorithm is used among the queues. For example, foreground queue may have absolute priority over background queue.

Therefore, no process in the background queue could run except the foreground queues are empty. If a process entered the foreground queue while a process from the background queue is running, the background queue process will be preempted and the new process from the foreground queue gets the CPU causing possible starvation for the background queue process. To address this problem, time slice can be used between the queues where each queue gets a certain portion of the CPU time which it can then schedule among the various processes in its queue. On the above example, for instance, the foreground queue can be given 80% of the CPU time for RR scheduling among its processes, whereas the background queue receives 20% of the CPU to give to its processes in FCFS manner.

Multilevel Feedback Scheduling algorithm is another implementation of multilevel queue where processes have the right to move between the several queues of the ready queue instead of being placed permanently into queues at arrival time based on their CPU-burst properties. A process that uses too much CPU time is degraded to a lower-priority queue and a process that waits too long is upgraded to a higher-priority queue.

For example, consider a MLFQ scheduler with three queues, Q0 with time quantum 8 milliseconds, Q1 with time quantum 16 milliseconds and Q2 on FCFS basis only when queues Q0 and Q1 are empty. A new job enters queue Q0 is served by FCFS and receives 8 milliseconds. If not finished in 8 milliseconds, it is moved to Q1. At Q1 the job is again served by FCFS and receives 16 milliseconds. If not completed, it is preempted and moved to Q2 where it is served in FCFS order with any CPU cycles left over from queues Q0 and Q1.

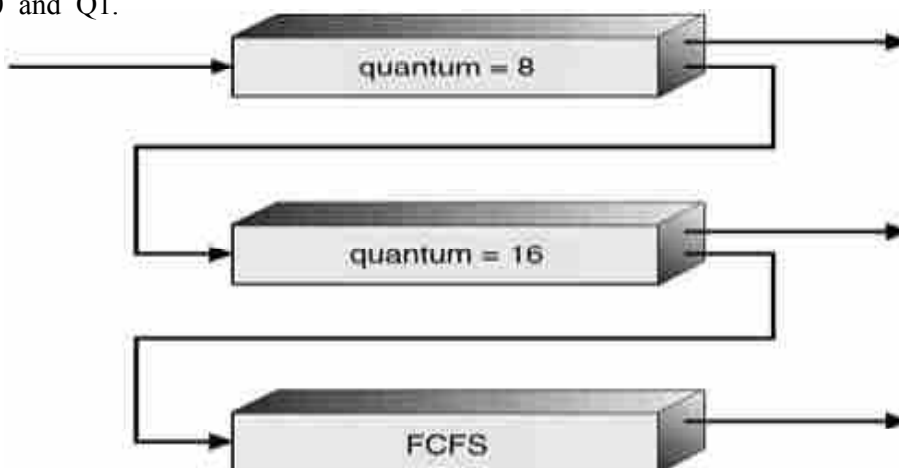

*Fig. 6.4 : Multilevel Feedback Queue*

In general, a MLFQ scheduler is defined by the following parameters :

- The number of queues
- The scheduling algorithm for each queue
- The method used to determine when to upgrade a process to a higher-priority and a lower-priority queue
- The method used to determine which queue a process will enter when that process needs service
- In conclusion, there are four primary methods to servicing the queues in a multilevel queue scheduling.
- In no movement between queues, all the jobs in the higher priority queue are
- serviced first before any job in a lower priority queue.

Movement between queues and adjust priorities assigned to jobs. When a time slice interrupt occurs, a job is pre-empted and moved to the end of the next lower priority queue if it is CPU bound. On the other hand, a job that is pre-empted because of an I/O operation is moved up to the next higher-level queue. In variable time quantum per queue, each queue is given a time quantum as long as the previous queue. If a job does not finish execution in the first-time quantum, it is moved down to the next lower priority queue. If it doesn't finish execution in the second time quantum (which will now be longer than the first-time quantum), it is moved down to the next lower priority queue and so on.

Aging is used to guard against indefinite postponement. This refers to a situation when a job somehow, due to a combination of certain circumstances, is unable to gain access to the CPU in order to execute. To guard against this possibility, whenever a job has not been serviced for a long period of time, it is moved up to the next higher-level queue. If it still is not serviced after a given period of time, it is moved up again to the next higher-level queue and so on.

From the definition of a multilevel queue scheduler, it is the most general CPU-scheduling algorithm but also the most complex one as it requires some means by which values for all the parameters can be selected.

### **6.8.7 Thread Scheduling :**

In a previous section, we have discussed what threads are and the two different implementations of a thread as user-level and kernel-level threads. Now let's see how the scheduler allocates execution time for threads in a process. When several processes are available with several threads, scheduling differs as to whether the threads are user-level or kernel-level. If the threads in a process are user-level, the kernel operates as usual only on processes since it is unaware of the threads and the scheduler schedules the processes by giving them control for a quantum. A thread scheduler inside a process will then use any of the scheduling algorithm discussed previously and picks a thread and grants the execution time.

This thread runs until it finishes its job or until the quantum time for the process ends in which case the system scheduler takes the CPU and grants it for another process. When the first process is granted the CPU again, that same thread resumes execution if it did not finish its execution earlier. In such

cases, only the threads within the process are affected and other processes in the system will run without being affected. If the threads in processes are of kernel-level, the kernel operates on the threads and picks them to run by giving a fixed quantum and forcibly suspend the thread if it exceeds the quantum allotted. The scheduler does not consider from which process a thread is picked to run.

The main difference between these two thread implementations scheduling is performance where the kernel-level scheduling requires a full context switch as every information related with a thread from one process must be maintained before a thread from another process gets to execute, making the algorithm too slow. But the kernel can take the cost associated with this context switching and make an optimal decision that can improve this performance problem. On the other hand, scheduling the kernel-level threads will not suspend an entire process when a thread in that process waits for I/O as user-level thread scheduling does.

One additional thing associated with user-level threads scheduling is the use of application-specific thread scheduler where the urgency of the threads will be examined and CPU is granted accordingly. This scheme increases parallelism in processes where several I/O bound threads are available.

### **6.8.8 Multiple Processor Scheduling :**

So far, our discussion was solely about scheduling processes and threads on a single processor system. However, there are also multi-processor systems with processes to be scheduled where the scheduling problem becomes even more complex. Let's consider a system with homogeneous or identical processors and discuss the different possible scheduling mechanisms. One scheduling possibility is to use asymmetric processing where one of the processors entitled as a master server and handle all scheduling, I/O processing and all other system activities while the remaining other processors handle only user codes.

Another approach in multiprocessor system can be symmetric processing where all processors have similar level and scheduling is done by each independently. Scheduling then proceeds by having the scheduler for each processor examine the ready queue and select a process to execute. The ready queue can be a separately maintained one by each processor or a common ready queue shared by all processors where the first scenario could make one processor be idle, with an empty queue, while another processor too busy, with full ready queue. But if a common ready queue is used, all processes go into one queue and are scheduled onto any available processor. However, it is important to ensure that no two processors choose the same process and that processes are not lost from the queue. Nearly all modern operating system supports this symmetric scheduling approach.

#### **❑ Check Your Progress – 2 :**

1. FCFS is the simplest non-pre-emptive scheduling algorithm.  
(True/False)
2. \_\_\_\_\_ is known to be the simplest, fair and most widely used scheduling algorithm most suitable for interactive systems  
(a) FCFS            (b) SJF            (c) Round Robin (d) None of these



3. Priority scheduling works as \_\_\_\_\_ policy
  - (a) Pre-emptive
  - (b) None Pre-emptive
  - (c) (a) or (b)
  - (d) None of these
4. Aging is used to guard against indefinite postponement. (True/False)
5. In Priority scheduling algorithm, Priority is expressed in terms of fixed range number such as 0 to 100.

### **6.9 Let's Sum Up :**

Process scheduling is a process of granting CPU for processes in the ready queue. The scheduler decides which process to grant the CPU according to a scheduling policy. Pre-emptive and non-pre-emptive scheduling policies are used by the scheduler where the pre-emptive policy forcibly suspends a process and gives the CPU to other processes in a ready queue while the non-pre-emptive scheduling policy simply waits for one process to finish its execution or voluntarily give-up the CPU and assigns another process to execute. FCFS is a non-pre-emptive scheduling algorithm which schedules processes according to their arrival time and results in starvation for short processes at the tail of long ones. SJF is another non-pre-emptive scheduling algorithm which schedules processes according to their CPU-burst time.

SRT is a pre-emptive scheduling algorithm which compares the remaining CPU-burst time of a running process with the CPU-burst time of a newly coming process and grants the CPU for the smallest CPU time requirement. RR is a pre-emptive scheduling algorithm that allocates a fixed quantum time for processes and allows them to run till that time expires. It is mainly suitable for interactive systems. Priority scheduling is where processes are assigned a value to indicate their priority for execution and get the CPU according to these values. It can be implemented both as pre-emptive and non-pre-emptive policy. Multilevel queue scheduling groups processes into various categories and uses different scheduling algorithms to schedule the groups while implementing another scheduling algorithm within a group.

Thread scheduling also varies according to the thread implementation. Multiprocessor systems have a more complex scheduling requirement that must be handled by the scheduler. Symmetric or asymmetric scheduling can be followed in such system where the asymmetric one is commonly used by all current operating systems.

### **6.10 Check Your Progress : Possible Answers :**

**Check Your Progress 1 :**

1. True, 2. (b), 3. (c), 4. False, 5. True, 6. True

**Check Your Progress 2 :**

1. True, 2. (b), 3. (c), 4. True, 5. False

### **6.11 Assignments :**

- Define the differences between pre-emptive and non-pre-emptive scheduling
- Write note on Multilevel Queue Scheduling
- Explain Thread Scheduling

**6.12 Activity :**

- Differentiate between following scheduling algorithms :
  - (a) FCFS and SJF
  - (b) RR and Priority

**6.13 Case Study :**

- Study scheduling mechanism used by windows operating system

**6.14 Further Reading :**

- Andrew S. Tanenbaum (2008). Modern Operating System. 3rd dition. Prentice–Hall.
- A Silberschatz, Peter B Galvin, G Gagne (2009). Operating System Concepts. 8th Edition. Wiley.
- William Stallings (2005). Operating Systems Internals and Design, Principles. 4th edition. Prentice Hall.

**UNIT STRUCTURE**

- 7.0 Learning Objectives
- 7.1 Introduction
- 7.2 Dead lock Conditions
- 7.3 Resource–Allocation (R–A) Graph
- 7.4 Deadlock Handling Mechanisms
- 7.5 Deadlock Detection
- 7.6 Deadlock Recovery
- 7.7 Deadlock Avoidance
- 7.8 Deadlock Prevention
- 7.9 Let's Sum Up
- 7.10 Check Your Progress : Possible Answers
- 7.11 Assignments
- 7.12 Activity
- 7.13 Case Study
- 7.14 Further Reading

**7.0 Learning Objectives :**

After completing this unit, learner should be able to :

1. Define dead lock
2. Describe necessary condition for deadlock
3. Draw a Resource–Allocation (R–A) Graph
4. Explain Deadlock Handling Mechanism

**7.1 Introduction :**

Deadlock is one of the problems of concurrency. In a multiprogramming environment, processes compute for resources. Processes wait for resources which are owned by other processes, in turn these processes wait for that process to release a resource. How does the operating system bring these processes to an agreement ?

In a multiprogramming system, processes are always in request of the several finite resources available in the system for their successful execution. The resources are partitioned into several types like Memory space, CPU cycles, files, and I/O devices (such as printers and tape drives). A process must request a resource before using it, and must release the resource after using it. When two or more processes simultaneously request for a resource, only one process will be allowed to use the resource at any instant of time to avoid unintended outcomes or corrupted outputs.

But for most programs, a process requires exclusive use of more than one resource at a time without exceeding the number of available resources in the system. For instance, two processes, A and B, may need to write document being scanned on a CD. Process A asks for the scanner first and is allowed to use it while process B asks for the CD recorder first because of its different programming structure and will also be permitted to use the recorder, After process A completes the scanning task, it requests for the CD recorder but will be denied as it is already being in use by process B. Process B now requests for the scanner without releasing the CD recorder which is requested by A. such situations causes both processes to be blocked or move to their waiting state and remain there forever as both are in need of same resource simultaneously resulting in a deadlock condition.

Deadlock can be defined as a situation whereby two or more processes get into a state whereby each is holding a resource that the other is requesting and processes are waiting in a loop for the resource to be released. None of these waiting processes will ever wake up and start execution as all the processes are blocked and needs an event to happen by one of these blocked processes to move to a running state.

At this point, it is important to distinguish between starvation and a deadlock. In starvation, a process cannot continue simply because it is not allocated the CPU while in deadlock, processes cannot continue because they are blocked and would remain in this state even if the CPU was available to them. Deadlock is a global condition rather than a local one which means that if were to analyze any process involved in a deadlock; we would not be able to find any error in the program of that process. The problem does not lie with any particular process, but with the interaction between a group of processes that are multitasked together. Deadlock effectively brings a large portion of the system to a halt.

Normally, a process goes through three consecutive steps to utilize a resource. These are :

- Request a resource
- Use the resource
- Release the resource

The operating system keeps in a system table the status of each resource as free or allocated and if allocated, to which process. If a requested resource is not available, the operating system can add the requesting process to a waiting queue of processes for this resource or the process itself waits a little while and checks again the resource as is the case in some systems. A resource can be either a preemptable or non-preempt able type. A preemptable resource is a type of resource that can be shared by taking away from a process owning it without negatively affecting it. A good example of such type is a memory. A non-preemptable resource, in contrary, is a non-sharable resource that cannot be taken from a process currently owning it without negatively affecting it. CD recorders are examples of non-preemptable resources. A deadlock happens when resources are non-preemptable types and is most common in multitasking and client/server environments.

### 7.2 Dead Lock Conditions :

For a deadlock to happen between processes, the following four conditions should hold simultaneously in a system.

**Mutual Exclusion :** Resources are non-preemptable and once a process is allocated a resource, it has exclusive access to that resource. This resource cannot be shared with other processes

**Hold and Wait :** A process must be holding exclusively at least one resource and still make a request for another resource that is currently hold by another process.

**No Preemption :** Resources can only be released voluntarily by the process itself rather than by the action of an external event

**Circular Wait :** Two or more processes must be in a circular chain where each process waits for a resource that the next process in the chain holds.

All these four conditions are necessary but not sufficient for a deadlock to occur. Only if the right combinations of unfortunate circumstances arise, then will deadlock manifest itself.

### 7.3 Resource-Allocation (R-A) Graph :

The four conditions of the deadlock can be described more precisely in terms of a directed graph called a system Resource allocation graph. This graph consists of a set of vertices  $V$  and a set of edges  $E$ .

$V$  is partitioned into two different types of nodes  $P = \{P_1, P_2, \dots, P_n\}$ , the set consisting all the active processes in the system, and  $R = \{R_1, R_2, \dots, R_m\}$ , the set consisting all resource types in the system. A directed edge from process  $P_i$  to resource type  $R_j$ , known as request edge, is denoted by  $P_i \rightarrow R_j$  and signifies that process  $P_i$  requested an instance of resource type  $R_j$  and is currently waiting for that resource. A directed edge from resource type  $R_j$  to process  $P_i$ , known as assignment edge, is denoted by  $R_j \rightarrow P_i$ ; it signifies that the process has been allocated an instance of resource  $R_j$ .

When a process  $P_i$  request an instance of resource type  $R_j$ , a request edge is inserted in the resource-allocation graph. The request edge will instantaneously change to an assignment edge when the request is fulfilled. When the process no longer needs access to the resource it releases the resource, and as a result the assignment edge is deleted.

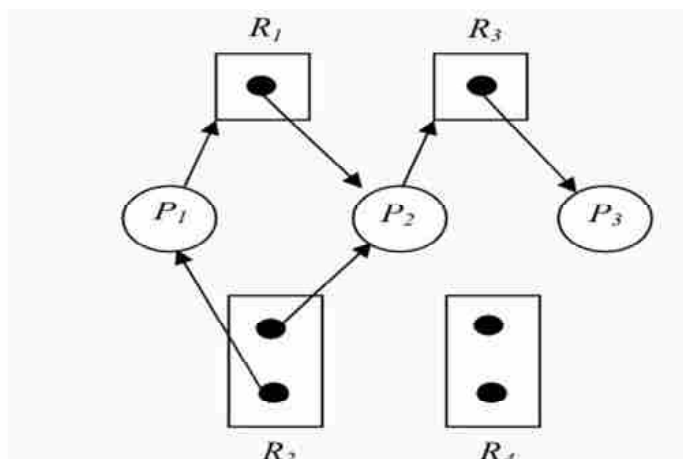

Fig. 7.1 : Resource Allocation Graph

Figure 7.1 depicts a resource allocation graph with three processes P1, P2 and P3; four different resources R1, R2, R3 and R4, and request from process to resource. Resource R2 and R4 have two instances while R1 and R3 are only single instance.

- Process P1 is holding an instance of resource type R2, and is waiting for an instance of resource type R1.
- Process P2 is holding an instance of resource type R1 and R2, and is waiting for an instance of resource type R3.
- Process P3 is holding an instance of resource type R3 and has no more requests further.

As can be depicted from the figure and also the description above, the processes possible to encounter deadlock are P1 and P2 as they have a waiting state. In general, if a cycle can be seen on the resource allocation graph and each resource type has exactly one instance, there is an implication for a deadlock and each process involved in that cycle is deadlocked.

In this case, a cycle in the graph is both a necessary and a sufficient condition for the existence of deadlock. However, if each resource type has several instances, then a cycle does not necessarily imply that a deadlock has occurred. In this case, a cycle in the graph is a necessary but not sufficient condition for the existence of deadlock.

If no cycle exists in the graph, then all the processes are free of any deadlock situation

In the resource graph diagram above, suppose process P3 requests an instance of resource type R2. Since no resource instance is currently available, a request edge  $P3 \rightarrow R2$  is added to the graph as in figure 7.6 below.

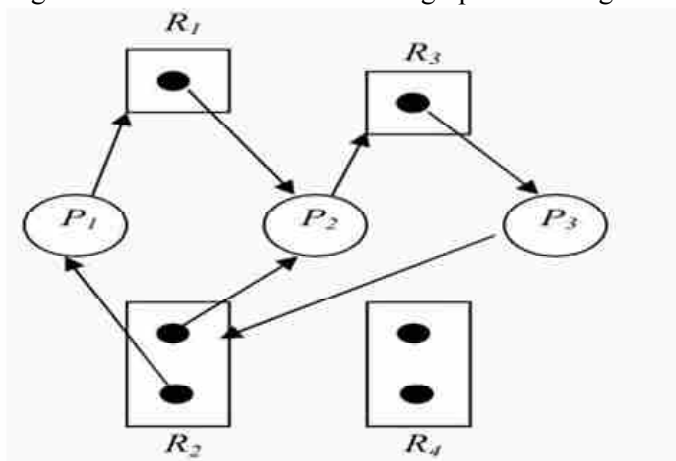

**Fig. 7.2 : Resource Allocation Graph With Deadlock**

At this point, two minimal cycles can be observed :

$P1 \rightarrow R1 \rightarrow P2 \rightarrow R3 \rightarrow P3 \rightarrow R2 \rightarrow P1$  and

$P2 \rightarrow R3 \rightarrow P3 \rightarrow R2 \rightarrow P2$

Moreover, Process P2 is waiting for resource R3, which is held by process P3. Process P3, on the other hand, is waiting for either process P1 or P2 to release resource R2. In addition, process P1 is waiting for P2 to release resource R1. These two conditions result in a deadlock situation for processes P1, P2 and P3.

To conclude, resource allocation graphs are tools that can be used to identify the occurrence of a deadlock given sequence of request/release. If a cycle can be seen in the graph, there is a possibility of deadlock none otherwise.

#### **7.4 Deadlock Handling Mechanisms :**

If deadlock happens how does the operating system has to solve the problem ? In this activity, we will discuss the four strategies of handling deadlock. But different operating systems provide similar kind of solution.

Four different strategies can be used towards overcoming deadlocks but each with their own corresponding advantages and drawbacks. These are :

1. **Ignoring** : ignore the problem altogether and pretend that deadlock has never occur in the system.
2. **Detection and Recovery** : make the system enter into a deadlock, detect the deadlock and devise actions to recover from the situation
3. **Avoidance** : carefully allocate resources to make sure no process will encounter a deadlock situation.
4. **Prevention** : structurally negate one of the four conditions that results a deadlock and prevent the occurrence.

A tradeoff between convenience and correctness has to be made though which is more important and to whom is a serious point to consider. In such systems, application developer must write programs that handle deadlocks.

#### **7.5 Deadlock Detection :**

In this method, the system uses neither deadlock avoidance nor prevention but allows deadlocks to happen. It then tries to detect when the deadlock happens and take actions to overcome the problem after it happened. Such systems employ deadlock detection and recovery algorithms that tracks resource allocation and process states, and rolls back and restarts one or more of the processes in order to remove the deadlock. Detecting a deadlock that has already occurred is easily possible since the resources that each process has locked and/or currently requested are known to the resource scheduler or OS.

##### **Deadlock detection with one resource of each type**

In such cases, systems with two instances of same resource are excluded and the system has only one instance of each resource type : one CD recorder, one Printer, and so on. If there is one or more cycle on the resource allocation graph of such system, it indicates a deadlock and any process within the cycle is deadlocked. Periodically invoking an algorithm to search for a cycle in the resource allocation graph enables the system to identify a deadlock. An algorithm to detect a cycle in a graph requires an order of  $n^2$  operations, where  $n$  is the number of vertices in the graph.

Several such algorithms exist among which we consider the simplest one. This algorithm defines a single data structure with list of nodes. The algorithm inspects the graph and terminates either when a cycle is found or has shown none exists by marking the arcs already inspected in the graph to avoid repetitive inspection. The algorithm operates in the following manner for each node  $N$ , in the graph

- Initialize list of nodes,  $L$ , to a blank list and label each of the arcs as unmarked

- Append a new node to the tail of L and examine if this node now appears twice
- in L. if it does, the algorithm exits as a cycle is identified.
- Inspect for any unmarked outgoing arcs from the given node and if so goto d and if not proceed to e
- Randomly pick one of the outgoing unmarked arc and mark it. Then follow it to the new current node and go to c
- This is a dead end and should be removed. Go to the node that was current node prior to this one and label it current node then jump to step c. if this node happens to be the initial node, then the diagram has no cycle and the algorithm terminates

Let's see how the algorithm operates with example. Let's take a system consisting of seven processes and six resources as shown in figure 7.3 (a) below.

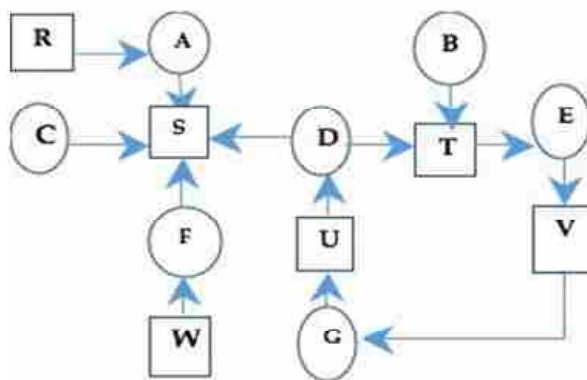

**Fig. 7.3(a) : Resource Allocation Graph**

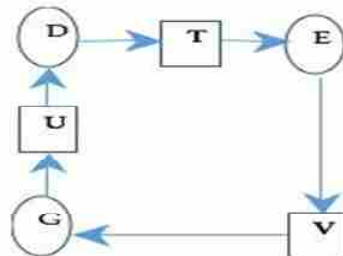

**Fig. 7.3(b) : Cycle extracted from (a)**

Let's start inspecting left to right and top to bottom as any node can be picked arbitrarily. Let's move resource R to the empty list L and initialize it. The only possible move is to A which adds process A to the list making  $L = \{R, A\}$ . Now move to S and L is updated to be  $\{R, A, S\}$ . S is a dead end with no outgoing arcs forcing us to move back to process A which in turn has no unmarked arcs that makes us retreat back to R and finish examining node R. now, the algorithm restarts for another node, say A emptying L. since this path has already been inspected, no need to trace it again for us and the algorithm also terminates instantly because of the presence of only a single arc from A to S. let's start from B and follow outgoing arcs till we arrive at D which makes L to be  $\{B, T, E, V, G, U, D\}$ . S or T can be taken randomly afterwards. If S is taken, this will lead to a dead end causing to move back to D. if T is picked, it will cause the algorithm terminate as this will make T to be found in L twice resulting in a cycle.



## **7.6 Deadlock Recovery :**

Once, the detection algorithm has succeeded in identifying a deadlock, several ways exist to overcome the situation. One alternative can be through notifying the operator about the deadlock and let the operator handle it manually. Another possibility can be letting the system recover from the deadlock automatically. Two different approaches are used to recover automatically : pre-emption and abortion.

### **Recovery through resource pre-emption**

This method works by temporarily taking away a resource from its current owner process and gives it to another process and finally returns back to the owner. i.e. successively preempt some resources from processes and give these resources to other processes until the deadlock cycle is broken.

Three important issues need to be addressed if to use this method

- **Victim** : which resources and which processes are to be pre-empted ? Cost minimization must be considered while ordering the pre-emption. The number of resources a deadlock process is holding and the time thus far used by the deadlocked process during its execution can be taken as cost factors.
- **Rollback** : if a process is pre-empted a resource, what is the fate of this process ? Obviously, the normal execution of the process can't proceed as it lacks some required resources. Thus, the process must be rolled back to some safe state and restarted from that state after the deadlock is solved. Since, in general, it is difficult to determine what a safe state is, the simplest solution could be a total rollback.
- **Starvation** : how can we guarantee that resources will not always be pre-empted from the same process ? Same process may always be picked as victim which leads to starvation. Including the number of rollback in the cost factor can be a solution to this problem.

This recovery method is difficult, if not impossible, as picking a process to pre-empt is highly dependent on the ease of taking back resources now held.

### **Recovery through process termination**

Killing one or more processes in a system may help to recover from deadlocks. Choose a victim process from the cycle and abort it so that other processes continue running by using the freed resources. This process can be repeated several times in the cycle till breaking the cycle is possible. A process outside a cycle can also be picked as a prey process where the resources hold by it are needed by one or more deadlocked processes. For example, two processes are running one holding a printer and requesting a CD reader while the other one using a CD reader and waiting for a printer. The two processes end up being deadlocked. If there is a third process with another identical printer and CD reader resource granted, killing this process makes the resources free which can then be allocated to the two processes solving the deadlock situation. Killing a process may not be easy. If the process was in the midst of updating a file or printing data on a printer, terminating it will leave the file in an incorrect state and the system needs to reset the printer to its correct state before printing the next job. Factors such as the priority of the process, how many more resources are required to complete the process, etc. affect the process

chosen as a victim. In general, It is best if the process chosen as a victim is a process that can resume from the beginning with no bad effect or the termination cost is minimal.

**7.7 Deadlock Avoidance :**

This is a conservative approach to handling deadlock that requires priori information about the maximum number of resources of each type that a process will ever request for in its lifetime, the maximum claim. This method is the simplest and most useful model which dynamically examines the resource-allocation state to ensure that there can never be a circular- wait condition. Resource-allocation state is defined by the number of available and allocated resources, and the maximum demands of the processes.

The idea is to ensure that a system consisting of a number of interacting processes remain in a safe state. A safe state is a situation where even if every single process simultaneously makes its maximum claim for resources at the same time, deadlock will still not occur and there is some scheduling arrangement to allow every process run and finish its execution. More formally, a system is in a safe state only if there exists a safe sequence of processes  $\langle P_1, P_2, \dots, P_n \rangle$  for the current allocation state. That is, for each  $P_i$ , the resource requests that  $P_i$  can still make can be satisfied by the currently available resources plus the resources held by all  $P_j$ , with  $j < i$ . In this situation, if the resources that  $P_i$  needs are not immediately available, then  $P_i$  can wait until all  $P_j$  have finished. When they have finished,  $P_i$  can obtain all of its needed resources, complete its designated task, return its allocated resources, and terminate.

When  $P_i$  terminates,  $P_{i+1}$  can obtain its needed resources, and so on. If no such sequence exists, then the system is said to be in unsafe state. Let's see with example safe and unsafe states.

Consider a system with 10 instances of one resource type and three different processes  $P_1, P_2$  and  $P_3$ .  $P_1$  currently is using 3 instances of the resource but requires 6 more instances,  $P_2$  has 2 instances being in use and needs 2 more while  $P_3$  also has 2 instances now and needs 5 more as shown in table below.

<i>Process</i>	<i>Currently has</i>	<i>Maximum requirement</i>
<i>P1</i>	3	9
<i>P2</i>	2	4
<i>P3</i>	2	7

From this, only 3 instances of the resource are available to be given to one of the processes. The system is in a safe state time  $t_0$  with  $\langle P_2, P_3, P_1 \rangle$  process sequence as the scheduler can immediately allocate the resource to  $P_2$  (since it requires only 2 more instances leaving only 1 instance free) and finish it which will then make all the 4 instances available to be used. Then with 5 instances at hand, the system can now schedule  $P_3$  to run to completion using all the available instances. Finally,  $P_1$  gets the chance to run as 7 instances are available and  $P_1$  only needs 6 of them. With this careful scheduling, the system is able to avoid deadlock making it safe.

On the other hand, assume at time  $t_1$ ,  $P_1$  requests one more instance and is granted making the total resource instances occupied by  $P_1$  4 and all the others as described on table 7.1 above. Now the system has only 2 instances

free. With these, P2 can run safely using both leftover instances. After P2's completion, the system will have 4 free instances to be given to one of the processes. However, both P1 and P3 require 5 instances to run which makes the scheduler get stuck as there is not enough free resource available. Hence, the two processes cannot get to completion moving the system to unsafe state.

Of course, deadlock is not guaranteed to occur in an unsafe state, but should the worst-case scenario arise, then deadlock will definitely occur.

A scheduling algorithm used to avoid such deadlock situation is known as the Banker's Algorithm which dynamically examines the resource-allocation state, that is defined by the number of available and allocated resources and the maximum demands of the processes, to ensure that a circular-wait condition can never exist. The name was chosen because the algorithm could be used in a banking system to ensure that the bank never allocated its available cash in such a way that it could no longer satisfy the needs of all its customers.

In this algorithm, the goal is not to entertain any request that can change the safe state to unsafe one. Whenever a request comes for a resource, the algorithm checks if fulfilling this request may result to unsafe state or not. If so, the request is postponed until later but otherwise granted.

This means the OS must always identify the process with the smallest number of remaining resources and make sure that the current number of remaining resources is always equal to, or greater than, the number needed for this process to run to completion. The Banker's algorithm works similar for both single and several resource types. For the Banker's algorithm to work, it needs to know three things :

- a. How much of each resource each process could possibly request ?
- b. How much of each resource each process is currently holding ?
- c. How much of each resource the system has available ?

Given  $n$  processes and  $m$  resource types in a system, the data structures required to implement the Banker's algorithm are as follows :

- $A$  : a vector specifying the available resources
- $P$  : a vector of possessed resources by processes
- $E$  : a vector of the existing instances of resources

The algorithm can now be stated as :

Find a process  $P$  in the  $n$  by  $m$  matrix whose number of resource request rejections are smaller or equal to  $A$ . if it is impossible to find one, the system will eventually go to deadlock since no process can be brought to completion. If more than one process is obtained, the choice is arbitrary. Assume this process has requested all the needed resources and finishes its execution. Mark the process terminated and update vector  $A$  by adding all the resources returned back by this process.

Repeat these two steps until either all the processes in the system comes to termination, which shows safety of the initial state, or until a deadlock happens in which case it was not. Like most algorithms, the Banker's algorithm involves some trade-offs.

The required number of resources by a process needs to be known for the algorithm to operate which is unavailable in most systems, making the

Banker's algorithm useless. Moreover, it is also unrealistic to assume static number of processes in a system as this number varies dynamically in most systems. The requirement that a process will eventually release all its resources on termination is insufficient for a practical system as waiting for hours even days for the resources to be released is unacceptable. In conclusion, there are few, if any, currently existing systems using this algorithm to avoid deadlocks.

### **7.8 Deadlock Prevention :**

Deadlock avoidance is almost impossible in real systems and as discussed previously, for a deadlock to occur, each of the four necessary conditions must hold. By ensuring that at least one of the four necessary conditions cannot hold, a system can prevent the occurrence of a deadlock. Let's elaborate on this approach by examining each of the four conditions separately.

**Mutual Exclusion :** Sharable resources, like Read-only files do not require mutually exclusive access making them out of a deadlock situation. If several processes attempt to open a read-only file at the same time, they can be granted simultaneous access to the file as a process never needs to wait for a sharable resource. The mutual exclusion condition, however, must hold for non-sharable resources like printer that cannot be simultaneously shared by several processes. Algorithms that avoid mutual exclusion are called non-blocking synchronization algorithms. In general, since some resources are inherently non-sharable, deadlocks cannot be avoided by denying the mutual exclusion condition.

**Hold and Wait :** To ensure the hold and wait condition never happens in a system, we must guarantee that whenever a process requests a resource, it does not hold any other resources. This requires process to request and be allocated all its resources before it begins execution which can be implemented by requiring that system calls requesting resources for a process precede all other system calls. Alternatively, this can be avoided by allowing a process to request resources only when the process has none. A process may request some resources and use them. To request for another additional resources, however, it must release all the resources that it is currently allocated. This method has two main drawbacks : Low resource utilization since many of the resources may be allocated but unused for a long period of time and starvation as a process that needs several popular resources may have to wait indefinitely.

**No Pre-Emption :** The third necessary condition for occurrence of a deadlock is that there be no pre-emption of resources that have been allocated. To ensure that this condition does not hold, the following algorithm can be used. If a process that is holding some resources requests another resource that cannot be immediately allocated to it, then all resources currently being held are released. The pre-empted resources are then added to the list of resources for which the process is waiting for and the process will be restarted only when it can regain its old resources, as well as the new ones that it is requesting.

This protocol is often applied to resources whose state can be easily saved and restored later such as CPU registers and memory space. It cannot generally be applied to such resources as printer and tape drives. If a process had been given the printer and is printing its output, taking away the printer forcibly because another resource requested by the process could not be granted

is a complicated task if not impossible. Attacking this condition is even more difficult than the previous two.

**Circular Wait Condition :** The last condition leading to a deadlock is the circular wait. This can be avoided by letting processes to wait but not in a circular fashion. One way to achieve this could be through assigning a global precedence number to resources and force processes to request for resources according to increasing precedence. That is, if a process holds some resources and the highest precedence of these resources is  $m$ , then this process cannot request any resource with ordering smaller than  $m$ . This forces resource allocation to follow a particular and non-circular ordering, so circular wait cannot occur. Alternatively, a system can set a rule specifying a process is entitled to only a single resource at any time. This allows holding only one resource per process and if a process requests another resource, it must first free the one it's currently holding (or hold-and-wait).

❑ **Check Your Progress – 1 :**

1. Deadlock is not the problems of concurrency. (True/False)
2. The deadlock can be described more precisely in terms of a system Resource allocation graph (True/False)
3. In Resource allocation graph, if cycle exists in the graph, then all the processes are free of any deadlock situation (True/False)
4. Banker's Algorithm ensures that a circular-wait condition can never exist. (True/False)

**7.9 Let's Sum Up :**

Processes may request and hold resources of the computer system. The order of allocating resources to processes is not predefined. A process may hold a resource and wait for another one without releasing the first one. This is a potential cause of deadlock, if another process is doing the same. To demonstrate this effect, one can use resource allocation graph. If cycle is occurred in the resource allocation graph, deadlock occurs.

A deadlock is a situation whereby a process holds and requests for another resource which is currently in use by another process that is looking for a resource captured by the first process. It is a potential in any operating system. A deadlock situation may occur if and only if four necessary conditions hold simultaneously in the system : mutual exclusion, hold and wait, no pre-emption, and circular wait. A system can use four different techniques in order to protect itself from a deadlock situation by determining which process sequencing is safe or not.

These are : using protocols to prevent or avoid deadlocks, ensuring that the system will never enter a deadlock state, allow the system to enter deadlock state, detect it, and then recover, and just ignore the problem altogether, and pretend that deadlocks never occur in the system.

**7.10 Check Your Progress : Possible Answers :**

1. False, 2. True, 3. False, 4. True

**7.11 Assignments :**

1. State the necessary conditions for deadlock to occur.
2. What are the various methods for handling deadlocks ?

**7.12 Activity :**

- Using R–A graph, describe deadlocks

**7.13 Case Study :**

- Deadlock recovery through resource pre–emption
- Deadlock recovery through process termination

**7.14 Further Reading :**

- Andrew S. Tanenbaum (2008). Modern Operating System. 3rd dition. Prentice– Hall.
- A Silberschatz, Peter B Galvin, G Gagne (2009). Operating System Concepts. 8th Edition. Wiley.
- William Stallings (2005). Operating Systems Internals and Design, Principles. 4th edition. Prentice Hall.

**BLOCK SUMMARY :**

- The most central notion in any operating system is a process.
- A process is a program currently running and that needs different kinds of resources to be allocated.
- A process also interacts with other processes frequently.
- An operating system is responsible to manage all the requirements of processes and also coordinate communication among different processes.
- A process state determines the current status of the process. There are three different states a process can be in.
- Every process has important information associated and this information are stored in a PCB by the operating system
- Thread is a basic unit of CPU utilization, consisting of a program counter, a stack, a set of registers, and a thread ID.
- A process can have one or more threads which share the same resources like the address space and opened files of a process.
- Dependency exists between threads and also they work collaboratively to accomplish a task and also share same resources.
- Threads can be in any of the process states, threads can create child threads, etc.
- Concurrently running processes compete for resources. These processes might communicate directly through message or share common variable on the memory.
- Concurrency have associated problems, namely race condition, starvation and deadlock. To avoid race condition, mutual exclusion is a solution.
- Process scheduling is a process of granting CPU for processes in the ready queue.
- The scheduler decides which process to grant the CPU according to a scheduling policy.
- pre-emptive policy forcibly suspends a process and gives the CPU to other processes in a ready queue
- non-pre-emptive scheduling policy simply waits for one process to finish its execution or voluntarily give-up the CPU and assigns another process to execute.
- FCFS is a non-pre-emptive scheduling algorithm
- SRT is a pre-emptive scheduling algorithm
- Multiprocessor systems have a more complex scheduling requirement that must be handled by the scheduler.

**BLOCK ASSIGNMENT :**

**Short Questions**

- Why is it not possible to move a process from ready to waiting state ?
- What is the reason for a process to stay in its ready state ?
- What kind of solution is test-and-set lock (TSL) provide ?
- How does deadlock happen in a system ?

- What are the two scheduling approaches used in a multi-processor system ?
- What is an interrupt handler ?

☐ **Long Question**

- Write detailed note on life cycle of a process
- Explain Process Control Block (PCB)
- Differentiate between interactive process and Daemons
- Discuss the problems of concurrency.
- What is the difference between semaphores and monitors ?
- Discuss the main differences between user-level thread scheduling and kernel-level thread scheduling
- Discuss the two scheduler types
- Discuss what a context switching is. What activities took place during a context switch ?





Dr. Babasaheb Ambedkar  
Open University Ahmedabad

BCAR-102/  
DCAR-102

# **Operating System and Software Installation**

---

## **BLOCK 3 : MEMORY AND STORAGE MANAGEMENT**

---

UNIT 8 MEMORY MANAGEMENT

UNIT 9 PAGE REPLACEMENT ALGORITHMS

UNIT 10 DEVICE MANAGEMENT

UNIT 11 FILE SYSTEMS

UNIT 12 DIRECTORIES AND FILE SYSTEM HIERARCHY

UNIT 13 FILE SYSTEM IMPLEMENTATION

# **MEMORY AND STORAGE MANAGEMENT**

## **Block Introduction :**

One of the fundamental functionality of the operating system is memory management. Processes, opened files, and input/output devices require memory to operate. This block introduces various memory management techniques and Page Replacement Algorithms. It discuss services of the operating system as I/O manager : File is the most visible aspect of an OS which is used to store and retrieve information from the disk this block also covers, files and important aspects of file such as File Naming, File Types, File Attributes and various. File Operations. Files are discussed from the operating system's kernel perspective. The operating system has a file management system by which secondary storage devices are utilized to maintain data permanently through files. The file system has a hierarchical arrangement so that lower level technical details of how files are handled by the system is abstracted from the higher level users or applications.

## **Block Objectives :**

The objective of this block is to elicit the importance of memory and describe the difference and usage of swapping, and partitions and work with the techniques of paging and segmentation and effectively address the different page replacement algorithms and working sets, it also explain the concept of caching. It describes the Characteristics of I/O Devices, Principles of I/O hardware, Principles of I/O Software and differentiate various Disk Scheduling Algorithms. It define : file, file structure, file access, file attribures and types of files. to explains in details about various file operations, Directories, types of directory organizations and directory operations. To Explain file system hierarchy, file storage allocation methods and methods of directory implementation. To discuss file sharing, file system consistency, file system reliability

## **Block Structure :**

**Unit 8 : Memory Management**

**Unit 9 : Page Replacement Algorithms**

**Unit 10 : Device Management**

**Unit 11 : File Systems**

**Unit 12 : Directories and File System Hierarchy**

**Unit 13 : File System Implementation**

**UNIT STRUCTURE**

- 8.0 Learning Objectives
- 8.1 Introduction
- 8.2 Swapping
- 8.3 Partitions
- 8.4 Paging
- 8.5 Implementation of Paging
- 8.6 Hierarchical Page Table
- 8.7 Address Translation With a 2-Level Page Table
- 8.8 Segmentation
- 8.9 Check Your Progress
- 8.10 Let Us Sum Up
- 8.11 Check Your Progress : Possible Answers
- 8.12 Assignment
- 8.13 Activity
- 8.14 Case Study
- 8.15 Further Reading

**8.0 Learning Objectives :**

After completing this unit, learner should be able to :

1. Upon completion of this unit you should be able to :
2. Elicit the importance of memory
3. Describe the difference and usage of swapping, and partitions
4. Work with the techniques of paging and segmentation

**8.1 Introduction :**

One of the fundamental functionality of the operating system is memory management. Processes, opened files, and input/output devices require memory to operate. How does the operating manage to allocate memory in a multiprogramming environment ?

Main memory (RAM) is one of the major component of a computer system. Every program to get executed must be loaded to the memory. Execution of the program happens once part or all of the program is loaded and the program becomes process. Hence, there are possibly number of processes running there will be an input queue of processes on the disk that wait to be brought to the memory. Obviously, programs needs to pass through several steps before they start to execute.

A program file or binary file is different from data or ASCII file in such a way that it has code (text) part, data part, and stack part. These parts are

attached to the memory at different stages/times. Attaching these components of a program is known as binding. Address binding of code or text, data, and stack parts of the program to memory addresses occurs at the following stages :

**Compile time :** Address binding is done at program compilation time. Absolute code is generated if the available memory is known in advance. Stating memory address is changed, the source code must be recompiled.

**Load time :** If the memory location to bind is not known in advance, a relocate table code has to be generated at the loading time, i.e., the time when the program is brought in to the memory.

**Execution time :** With the support from hardware, for example, using base and limit registers, address maps can be done at execution time. Address binding can be delayed until execution time if the process has to be moved from segment to segment.

The steps of program execution is illustrated in the Fig. 8.1.

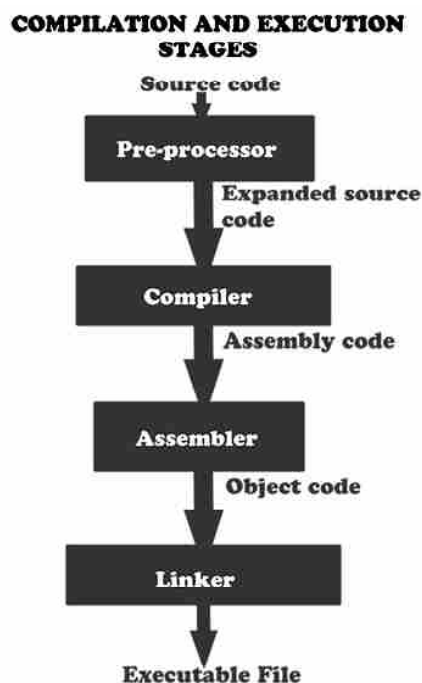

*Fig. 8.1 : Steps of Program Execution*

**Logical (Virtual) Address Space**

Processes generate memory addresses to referencing its own memory location or others. These addresses generated by a process is known as logical or virtual addresses. Collection of such addresses generated by the process, is called logical address space. It starts from 0 to the size of the process.

**Physical Address Space**

The actual address generated by the memory management unit where the instruction and data is located on the physical memory. It can start anywhere a process is located. Collection of such addresses is referred as physical address space.

Logical and physical addresses are entirely similar in the two stages of address binding, i.e., on compile time and load time. They differ at the execution time of the process. Once the process to execute it produces the logical (virtual) address. This address must be translated to physical address to access the instruction and/or data. The hardware device that performs such a translation

is known as Memory Management Unit (MMU). MMU maps logical (virtual) address to physical address.

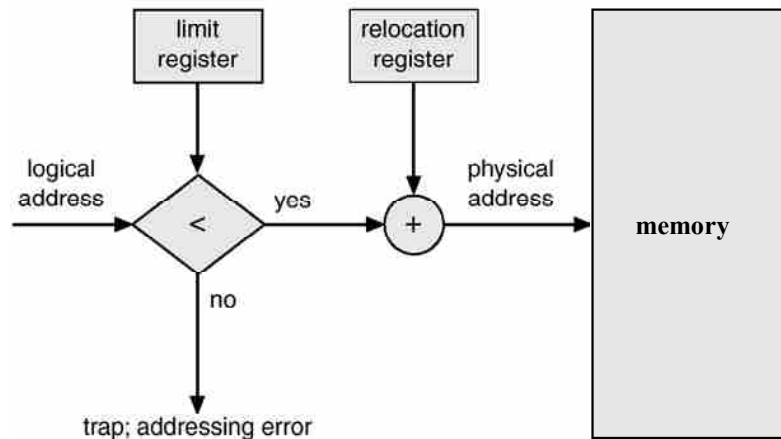

**Fig. 8.2 : MMU's Mapping of Virtual Address to Physical Address**

Every process stores its start address of the process in the base/relocation register. When logical address is generated by the CPU, it is checked whether it is less than the content of the limit register. If it is in the MMU, the logical address is added to the value stored in the base/relocation register to produce the physical address. Otherwise, the process is trying to the memory location of other processes, access is denied and a trap is generated. The illustration is shown in Fig. 8.2. The user program doesn't know the value of the physical address.

For example, 510 is the logical address generated by the CPU. If 510 is greater than the content of limit register, a trap is generated for addressing error. Otherwise, it is added to the contents of the relocation register, i.e., 16000. The MMU produces 16510 as a physical address.

## **8.2 Swapping :**

Concurrently running multiple processes on a uni-processor environment requires larger memory. How large the memory be ? If we set the size always we want to run additional process that requires more memory. One cannot set the exact size of the memory that is large enough for all the processes on the system. The solution for this problem is swapping.

### **What is Swapping ?**

It is impractical to imagine the size of main memory to accommodate all the processes. Normally, if you check the number of processes Windows and Linux are executing at a time, more than 60 at start up. Maintaining all these processes in the primary memory is costly as large area of memory is needed. A process can be swapped temporarily out of the main memory and stored in the disk is the simplest strategy.

It is the responsibility of the memory manager to swap ideal processes fast enough in the memory. If you consider any CPU-scheduling algorithm, there is a mechanism that identifies a process that finishes its quanta recently, or has least priority, or least waiting time, or long execution time. In a specific scheduling algorithms, there are processes that are scheduled last. So, the memory manager swaps these processes to the disk in order to larger space in the main memory and be able to execute new processes.

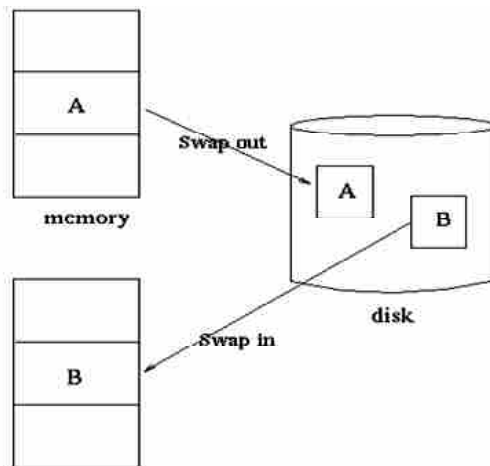

**Fig. 8.3 : Block Diagram for Swapping of Process A and Process B**

At the time when the need arises the swapped out processes will be swapped into the memory in its entirety. Idle processes are stored in a disk unless there is a need to run them, upon which they will be swapped in. Usually, the process replaces another swapped out process from the memory and claims the same address space it used to have previously for the purpose of address binding.

### 8.3 Partitions :

Multiple processes reside in the main memory at a time. Main memory is partitioned into two : resident operating system, also known as kernel space, in low memory area and user space where user processes are held in high memory area.

#### Single Partition Allocation

Base/relocation register is used to hold the starting physical address for the user process. They provide protection for the operating system code and data from being changed by user processes. The logical address generated by user processes should not be greater than the limit register. Otherwise, the process is trying to address a memory location which is not part of its own address space. The partition size is fixed. The early IBM mainframe operating system, OS/MFT (Multiprogramming with Fixed Number of Tasks), was a successful single partition operating system.

#### Multiple Partition Allocation

The user space is divided into multiple partitions. The free partitions are referred to as holes. Holes have various size, which are scattered throughout the main memory. A process arriving to the memory will be allocated to a hole which is large enough to hold it.

The operating system is responsible to keep track of information about the allocated and free (hole) partitions.

#### Dynamic Memory Allocation

It is an algorithm that addresses how to allocate a process with n bytes to a list of free holes. The following are the three different algorithms :

**First-fit** : Starting from the first hole, scan for a hole which is large enough for the process to be allocated.

**Best-fit** : Scan for the entire holes in the list, allocated the process in a hole that produces a smallest leftover or internal fragmentation. It is best allocation algorithm but poor performance, since it has to scan all the free holes.

**Next-fit** : Scanning starts from the location of the last placement, and chooses the next available block that is large enough.

**Worst-fit** : Scan for the entire holes in the list, allocated the process in a hole that produces a largest leftover or internal fragmentation. It is worst allocation algorithm with poor performance, since it has to scan all the free holes.

First-fit and best-fit algorithms are better in terms of storage utilization.

### **Fragmentation**

As a process is not large enough to take the entire space of a hole, there is a space which is unused. Such spaces are referred as fragmented spaces. There are two kinds of fragmentations :

- External fragmentation
- Internal fragmentation

#### **External fragmentation**

It refers to the total memory space which is left over when holes are assigned to processes. These spaces are not contiguous.

#### **Internal fragmentation**

The assigned process is not large enough to take the entire space of the hole producing an internal fragmentation.

To reduce external fragmentation a technique called compaction is used. Compaction moves all allocated memory spaces to one end of the main memory in order to produce one larger free memory block. It is expensive activity due to the effort it takes to move the content. Moreover, the relocation should be dynamic, since compaction is done at execution time.

## **8.4 Paging :**

Both single partition and multiple partitions allocation are inefficient in the use of memory; the former results in internal fragmentation, the latter in external fragmentation.

Suppose, however, that main memory is partitioned into equal fixed-size chunks that are relatively small known as frames or page frames (size is power of 2, between 512 bytes and 8192 bytes). And that each process is also divided into small fixed-size chunks of the same size known as pages. To run a program of size  $n$  pages, need to find  $n$  free frames and load program. In this approach, internal fragmentation happens only on a fraction of the last page of a process. There is no external fragmentation.

While processes occupy some of the frames, there are also free frames. A list of free frames is maintained by the operating system.

The page table shows a frame location for each page of a process. The logical address generated by the process consists of a page number and an offset within the page. A logical address is the location of a word relative to the beginning of the process.

The CPU translates the logical address into a physical address. Logical-to-physical address translation is done by Memory Management Unit (MMU). The processor uses the page table to convert the logical address (page number, offset) to produce a physical address (frame number, offset).

Page number (p) – used to identify the page's index in a page table which contains base address of each page in physical memory.

Page offset (d) – united with start address to define the physical memory address that is sent to the physical memory.

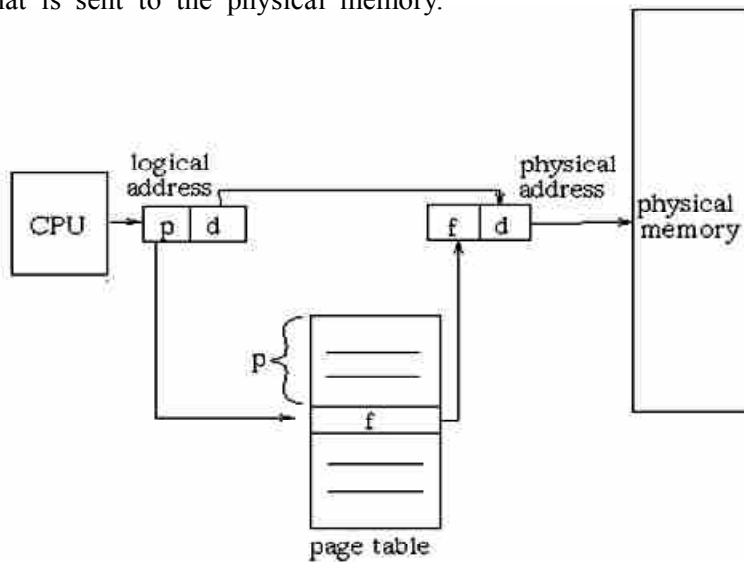

**Fig. 8.4 : Block Diagram for Mapping Logical Address to Physical Address**

Assume that the logical memory has four pages (page 0 to page 3). The physical memory has eight frames. The page table entry shows the mapping of the logical pages to the frames. Consider page size of 1KB. Let the logical address generated by the processor is 1300. To determine the frame where this page is located, divide the logical address by the page size, 1024, resulting page 1. Locating the frame that corresponds to page 1 is frame 6. The base address is the frame number times the frame size, which is equal to page size, results 6144.

To find the page offset, compute the remainder of the 1300 by page size. The page offset is 276. The physical address is obtained by adding the base address with the page offset, which is 6420.

			Frame number	
page 0	0	5	0	
page 1	1	6	1	page 2
page 2	2	1	2	page 3
page 3	3	2	3	
logical	page		4	
memory	table		5	page 0
			6	page 1
			7	physical
				memory

**Fig. 8.5 : Paging Using Page Table Data Structure**



If the page do not have an entry in the page table, you cannot located the corresponding frame number. That shows the page is not loaded to the physical memory. In such cases, a page fault is said to happen and the operating system is notified of a trap. The process which results a page fault is blocked. Operating system loads the page that creates a page fault and brings the process to ready state.

### **8.5 Implementation of Paging :**

A process executes only in main memory that memory is referred to as real memory. In modern operating systems part of the hard disk can be used as memory. This memory is referred to as virtual memory. Virtual memory facilitates the effective management of multiprogramming.

In the case of simple paging, each process has its own page table, and when all of its pages are loaded into main memory, the page table for a process is created and loaded into main memory. Each page table entry contains the frame number of the corresponding page in main memory. A page table is also needed for a virtual memory scheme based on paging. Again, it is typical to associate a unique page table with each process. Because only some of the pages of a process may be in main memory, a bit is needed in each page table entry to indicate whether the corresponding page is absent/present bit (P) in main memory or not. If the bit indicates that the page is in memory, then the entry also includes the frame number of that page.

The page table entry includes a modify (M) bit, indicating whether the contents of the corresponding page have been altered since the page was last loaded into main memory. If there has been no change, then it is not necessary to write the page out when it comes time to replace the page in the frame that it currently occupies.

Caching disabled	Referenced	Protection	Absent/ Present Bit	Modify Bit	Page Frame Number
------------------	------------	------------	---------------------------	---------------	----------------------

*Figure : Page Table Enrty*

### **8.6 Hierarchical Page Table :**

In systems with larger address space the one-level paging results in too long page tables which exceed the size of a page. Consequently they have to be paged as well as the program code and data. For example the 32-bit addressing system with 4 Kbyte (212) pages would have page tables with max 1 M entries. If each entry takes 4 bytes, the page table becomes 4 Mbytes long, or  $4 \times 220 / (212) = 1024$  pages. Therefore a two-level paging scheme is needed.

This first level PT is small enough to store in memory, PT1 with 10-bits. It contains one PTE for every page of PTEs in the 2nd level PT, which reduces space by a factor of one or two thousand. But since we still have the 2nd level PT, PT2 also with 10-bits, we have made the world bigger not smaller.

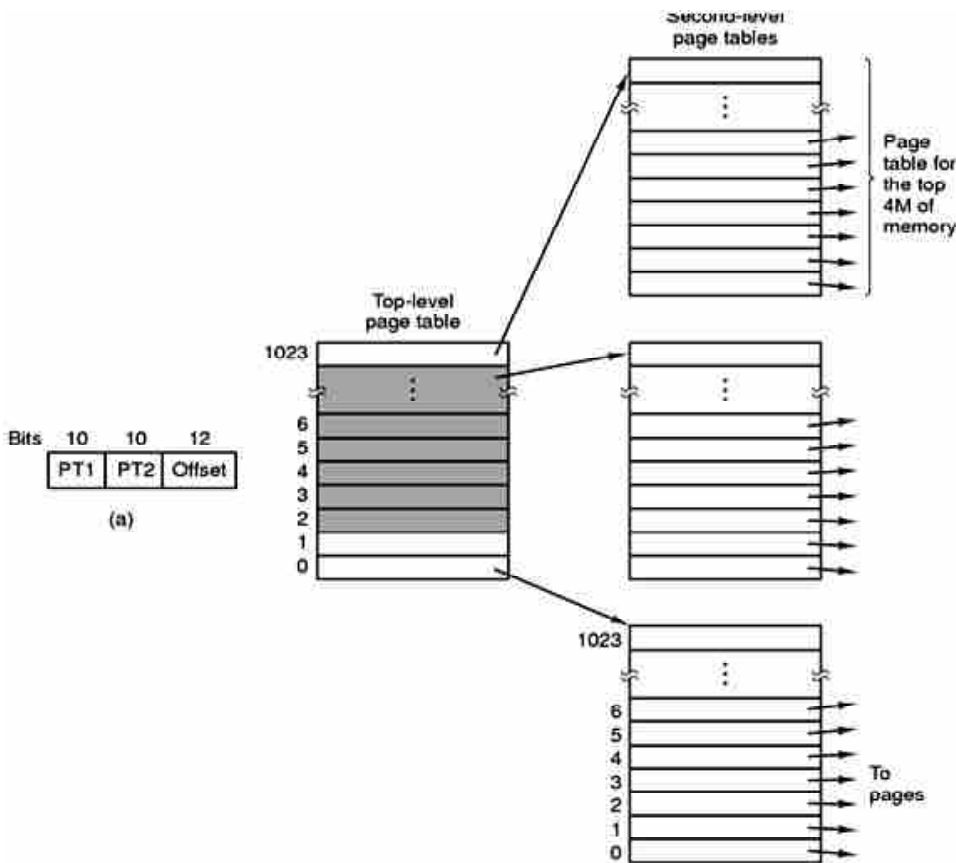

Fig. 8.6 : Two-Level paging

Don't store in memory those 2nd level page tables all of whose PTEs refer to unused memory. That is use demand paging on the (second level) page table. This idea can be extended to three or more levels.

**8.7 Address Translation With a 2-Level Page Table :**

For a two level page table the virtual address is divided into three pieces, as in Figure (a). PT1 gives the index into the first level page table. Follow the pointer in the corresponding PTE to reach the frame containing the relevant 2nd level page table. PT2 gives the index into this 2nd level page table. Follow the pointer in the corresponding PTE to reach the frame containing the (originally) requested page. Offset gives the offset in this frame where the originally requested word is located.

**Inverted Page Tables**

Usually, the logical address space is much bigger than the size of physical memory. In particular, with 64-bit addresses, the range is  $2^{64}$  bytes, which is 16 million terabytes. If the page size is 4KB and a page table entry is 4 bytes, a full page table would be 16 thousand terabytes.

A two level table would still need 16 terabytes for the first level table, which is stored in memory. A three level table reduces this to 16 gigabytes, which is still large and only a 4-level table gives a reasonable memory footprint of 16 megabytes.

An alternative is to instead keep a table indexed by frame number. The content of entry  $f$  contains the number of the page currently loaded in frame  $f$ . This is often called a frame table as well as an inverted page table.

Now there is one entry per frame. Again using 4KB pages and 4 byte PTEs, we see that the table would be a constant 0.1% of the size of real memory.

But on a Translation Lookaside Buffer (TLB) miss, the system must search the inverted page table, which would be hopelessly slow except that some tricks are employed. Specifically, hashing is used.

A Translation Lookaside Buffer or TLB is an associate memory where the index field is the page number. The other fields include the frame number, dirty bit, valid bit, etc.

Note that, unlike the situation with a page table, the page number is stored in the TLB; indeed it is the index field.

A TLB is small and expensive but at least it is fast. When the page number is in the TLB, the frame number is returned very quickly.

On a miss, a TLB reload is performed. The page number is looked up in the page table. The record found is placed in the TLB and a victim is discarded (not really discarded, dirty and referenced bits are copied back to the page table entry). There is no placement question since all TLB entries are accessed at the same time and hence are equally suitable. But there is a replacement question.

### **8.8 Segmentation :**

A user program is divided into segments. Rather than dividing the program into unstructured pages, it divides the program based on the different sections, segments. The size of the segments are not necessarily equal. As with paging, a logical address using segmentation consists of two parts, in this case a segment number and an offset.

Since segments are unequal in size, segmentation is similar to dynamic partitioning. The difference with dynamic partitioning is that with segmentation a program may occupy more than one partition. Moreover, these partitions need not be contiguous. Segmentation avoids internal fragmentation but, similar to dynamic partitioning, it suffers from external fragmentation.

Segmentation gives much more sense for programmers, compared to paging, in visualizing and organizing programs and data. Typically, the programmer or compiler will assign programs and data to different segments. For purposes of modular programming, the program or data may be further broken down into multiple segments.

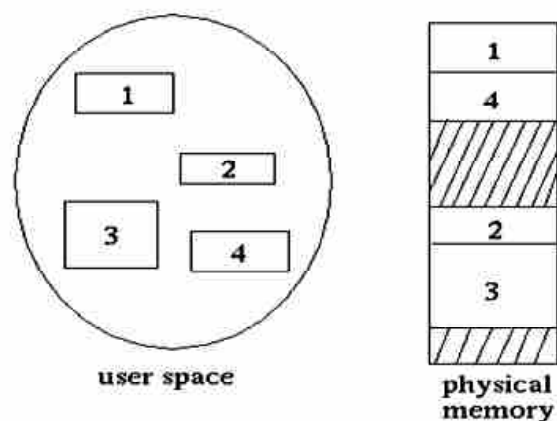

*Fig. 8.7 : Segments in Physical Memory*

A segment refers to a logical unit of a program which is code/text, stack, local variables, global variables, etc. Figure 8.7 illustrates the association of user space and physical memory allocation for segments of a program.

In this case, there is no simple relationship between logical addresses and physical addresses. Similar to paging, logical address consists of segment number and offset. A segment table is used to map logical addresses to physical addresses. In the segment table, each segment table entry would have to give the starting address in main memory of the corresponding segment using the base register. The entry should also provide the length of the segment, to assure that invalid addresses are not used using the limit register.

**8.8 Check Your Progress :**

❖ **Match the following :**

A	Swapping	1	Bringing and taking of pages a process in and out of a memory
B	Paging	2	It refers to the total memory space which is left over when holes are assigned to processes.
C	Segmentation	3	The assigned process is not large enough to take the entire space of the hole
D	External fragmentation	4	Replacing a process in a memory with another one from a disk
E	Internal fragmentation	5	Dividing parts of a process from programmer point of view

**8.10 Let's Sum Up :**

The physical memory is not large enough to run several processes at a time. Different mechanisms were applied and memory allocation for processes is handled by the operating system. The mechanisms were swapping of processes in and out of memory, partitioning of memory, paging of processes, and segmentation. This unit dealt with detailed implementation issue of paging and segmentation techniques.

When a given page is brought to memory, another page should be evicted. How is a victim page selected ? What algorithms do we have to select this victim page ? The next unit addresses these questions.

**8.11 Check Your Progress : Possible Answers :**

❖ **Match the following :**

A-4      B-1      C-5      D-3      E-2

**8.12 Assignment :**

- Explain what will happen if a page is not found in the physical memory.
- Why hierarchical pages structure is required ?
- When does the address binding activity is done ?
- What is the purpose of limit register ?

**Operating System and  
Software Installation**

**8.13 Activity :**

- Describe the different parts of a program.

**8.14 Case Study :**

- Windows Memory Management

**8.15 Further Reading :**

- Applied Computer Science : CSI 3101, INTRODUCTION TO OPERATION SYSTEMS, William Korir

# *PAGE REPLACEMENT ALGORITHMS*

## UNIT STRUCTURE

- 9.0 Learning Objectives
- 9.1 Introduction
- 9.2 The Optimal Page Replacement Algorithm (PRA)
- 9.3 The Not Recently Used (NRU) PRA
- 9.4 First In, First Out (FIFO) PRA
- 9.5 Second Chance PRA
- 9.6 Clock PRA
- 9.7 Last In, First Out (LIFO) PRA
- 9.8 Least Recently Used (LRU) PRA
- 9.9 The Aging PRA
- 9.10 Check Your Progress
- 9.11 Let Us Sum Up
- 9.12 Check Your Progress : Possible Answers
- 9.13 Assignment
- 9.14 Activity
- 9.15 Case Study
- 9.16 Further Reading

### 9.0 Learning Objectives :

Upon completion of this unit you should be able to :

- Effectively address the different page replacement algorithms and working sets
- Explain the concept of caching

### 9.1 Introduction :

In the previous activity, we demonstrated how pages are managed. If a page is found on the physical memory, the instruction continue to execute. But, if page fault happens, the required page shall be brought to the memory replacing a victim page. How is the victim page selected ? We require an algorithm which is efficient enough in such a way that it minimizes subsequent page faults.

A page is brought into the memory when it is referenced. When a process first is started, there will be number of page faults. After a while, the number of page faults should drop to a very low level. The operating system is responsible to identify a victim page to be dispossessed from memory during a page fault.

These are solutions to the replacement a page in a memory question. A better solution take advantage of locality when choosing the victim page to replace.

**Temporal locality :** If a word is referenced now, it is likely to be referenced in the near future. This argues for caching referenced words, i.e. keeping the referenced word near the processor for a while.

**Spatial locality :** If a word is referenced now, nearby words are likely to be referenced in the near future. This argues for pre fetching words around the currently referenced word.

Temporal and spatial locality are lumped together into locality : If any word in a page is referenced, each word in the page is likely to be referenced. So it is good to bring in the entire page on a miss and to keep the page in memory for a while.

At the very beginning a program has no record to refer for locality. At this point the paging system is said to be undergoing a cold start.

Pages belonging to processes that have terminated are of course perfect choices for victims. Pages belonging to processes that have been blocked for a long time are good choices as well.

### **9.2 The Optimal Page Replacement Algorithm (PRA) :**

Replace the page whose next reference will be furthest in the future. Also known as Belady's minimum algorithm. Provably optimal. That is, no algorithm generates fewer page faults. The probability of implementing this algorithm is impractical, because it requires predicting the future. It has good upper bound on performance.

### **9.3 The Not Recently Used (NRU) PRA :**

Divide the frames into four classes and make a random selection from the lowest nonempty class.

- Not referenced, not modified.
- Not referenced, modified.
- Referenced, not modified.
- Referenced, modified.

Assumes that in each page table entry there are two extra flags R (for referenced) and M (for modified, or D, for dirty).

NRU is based on the belief that a page in a lower priority class is a better victim.

If a page is not referenced, locality suggests that it probably will not be referenced again soon and hence is a good candidate for eviction.

If a clean page (i.e., one that is not modified) is chosen to evict, the operating system does not have to write it back to disk and hence the cost of the eviction is lower than for a dirty page.

#### **How it works :**

When a page is brought in, the operating system resets R and M (i.e.  $R = M = 0$ ).

On a read, the hardware sets R.

On a write, the hardware sets R and M.

Since every page is brought into the memory when referenced, its R bit is set. It must be cleared frequently. At every k clock ticks, the operating system resets all R bits.

#### **9.4 First In, First Out (FIFO) PRA :**

Belady's Anomaly : Can have more frames yet generate more faults. The natural implementation is to have a queue of nodes each referring to a resident page (i.e., pointing to a frame). When a page is loaded, a node referring to the page is appended to the tail of the queue. When a page needs to be evicted, the head node is removed and the page referenced is chosen as the victim.

This sound good, but only at first. The trouble is that a page referenced say every other memory reference and thus very likely to be referenced soon will be evicted because we only look at the first reference.

#### **9.5 Second Chance PRA :**

Similar to the FIFO PRA, but altered so that a page recently referenced is given a second chance.

When a page is loaded, a node referring to the page is appended to the tail of the queue. The R bit of the page is cleared. When a page needs to be evicted, the head node is removed and the page referenced is the potential victim.

If the R bit is unset (the page hasn't been referenced recently), then the page is the victim .If the R bit is set, the page is given a second chance. Specifically, the R bit is cleared, the node referring to this page is appended to the rear of the queue (so it appears to have just been loaded), and the current head node becomes the potential victim.

##### **What if all the R bits are set ?**

We will move each page from the front to the rear and will arrive at the initial condition but with all the R bits now clear. Hence we will remove the same page as FIFO would have removed, but will have spent more time doing so. We might want to periodically clear all the R bits so that a long ago reference is forgotten (but so is a recent reference).

#### **9.6 Clock PRA :**

Same algorithm as second chance, but a better potentially implementation for the nodes : Use a circular list with a single pointer serving as both head and tail.

Let us begin by assuming that the number of pages loaded is constant.

So the size of the node list in second chance is constant.

Use a circular list for the nodes and have a pointer pointing to the head entry. Think of the list as the hours on a clock and the pointer as the hour hand. (Hence the name clock PRA.)

Since the number of nodes is constant, the operation we need to support is replace the oldest, unreferenced page by a new page.

Examine the node pointed to by the (hour) hand. If the R bit of the corresponding page is set, we give the page a second chance : clear the R bit, move the hour hand (now the page looks freshly loaded), and examine the next node

Eventually we will reach a node whose R bit is clear. The corresponding page is the victim.

Replace the victim with the new page (may involve 2 I/Os as always).



Update the node to refer to this new page.

Move the hand forward another hour so that the new page is at the rear.

Thus, when the number of loaded pages (i.e., frames) is constant, the algorithm is just like second chance except that only the one pointer (the clock hand) is updated.

The number of frames can change when we use a so called local algorithm where the victim must come from the frames assigned to the faulting process. In this case we have a different frame list for each process. At times we want to change the number of frames assigned to a given process and hence the number of frames in a given frame list changes with time.

#### **How does this affect 2nd chance ?**

We now have to support inserting a node right before the hour hand (the rear of the queue) and removing the node pointed to by the hour hand.

The natural solution is to double link the circular list.

In this case insertion and deletion are a little slower than for the primitive second chance (double linked lists have more pointer updates for insert and delete).

So the trade-off is : If there are mostly inserts and deletes, and granting second chances is not too common, use the original 2nd chance implementation. If there are mostly replacements, and you often give nodes a 2nd chance, use clock.

### **9.7 Last In, First Out (LIFO) PRA :**

All but the last frame are frozen once loaded so you can replace only one frame. This is especially bad after a phase shift in the program as now the program is references mostly new pages but only one frame is available to hold them, which is bad.

### **9.8 Least Recently Used (LRU) PRA :**

When a page fault occurs, choose as victim that page that has been unused for the longest time, i.e. the one that has been least recently used.

**LRU is definitely :**

**Implementable :** The past is knowable.

**Good :** Simulation studies have shown this.

**Difficult.** Essentially the system needs to either :

Keep a time stamp in each page table entry, updated on each reference and scan all the page table entries when choosing a victim to find the page table entry with the oldest timestamp.

Keep the page table entries in a linked list in usage order, which means on each reference moving the corresponding PTE to the end of the list.

Simulating (Approximating) LRU in Software

#### **The Not Frequently Used (NFU) PRA**

Keep a count of how frequently each page is used and evict the one that has been the minimum score. Specifically :

- Include a counter (and reference bit R) in each page table entry.
- Set the counter to zero when the page is brought into memory.

- Every  $k$  clocks, perform the following for each page table entry.
- Add  $R$  to the counter.
- Clear  $R$ .
- Choose as victim the page table entry with minimum count.

### **9.9 The Aging PRA :**

NFU doesn't distinguish between old references and recent ones. The following modification does distinguish.

- Include a counter (and reference bit,  $R$ ) in each PTE.
- Set the counter to zero when the page is brought into memory.
- Every  $k$  clock ticks, perform the following for each PTE.
- Shift the counter right one bit.
- Insert  $R$  as the new high order bit of the counter.
- Clear  $R$ .
- Choose as victim the PTE with lowest count.

Aging does indeed give more weight to later references, but an  $n$  bit counter maintains data for only  $n$  time intervals; whereas NFU maintains data for at least  $2n$  intervals.

#### **Working Sets and Thrashing**

Normally, if a process takes a page fault and must wait for the page to be read from disk, the operating system runs a different process while the I/O is occurring. Thus page faults are "free" ?

#### **What happens if memory gets overcommitted ?**

Suppose the pages being actively used by the current processes don't all fit in physical memory.

Each page fault causes one of the active pages to be moved to disk, so another page fault will occur soon.

The system will spend all its time reading and writing pages, and won't get much work done.

This situation is called thrashing; it was a serious problem in early demand paging systems.

#### **How to deal with thrashing ?**

If a single process is too large for memory, there is nothing the operating system can do. That process will simply thrash. If the problem arises because of the sum of several processes :

Figure out how much memory each process needs.

Change scheduling priorities to run processes in groups that fit comfortably in memory : must shed load.

**Working Sets** : conceptual model proposed by Peter Denning to prevent thrashing.

**Informal definition** : the collection of pages a process is using actively, and which must thus be memory-resident to prevent this process from thrashing.

If the sum of all working sets of all runnable process's threads exceeds the size of memory, then stop running some of the threads for a while.

Divide processes into two groups : active and inactive :

When a process is active its entire working set must always be in memory : never execute a thread whose working set is not resident. When a process becomes inactive, its working set can migrate to disk. Threads from inactive processes are never scheduled for execution. The collection of active processes is called the balance set. The system must have a mechanism for gradually moving processes into and out of the balance set. As working sets change, the balance set must be adjusted.

#### **How to compute working sets ?**

Denning proposed a working set parameter T : all pages referenced in the last T seconds comprise the working set. Can extend the clock algorithm to keep an idle time for each page. Pages with idle times less than T are in the working set.

Difficult questions for the working set approach :

- a. How long should T be (typically minutes) ?
- b. How to handle changes in working sets ?
- c. How to manage the balance set ?
- d. How to account for memory shared between processes ?

**Page Fault Frequency** : another approach to preventing thrashing. Per-process replacement; at any given time, each process is allocated a fixed number of physical page frames. Monitor the rate at which page faults are occurring for each process. If the rate gets too high for a process, assume that its memory is overcommitted; increase the size of its memory pool. If the rate gets too low for a process, assume that its memory pool can be reduced in size. If the sum of all memory pools don't fit in memory, deactivate some processes.

In practice, today's operating systems don't worry much about thrashing : With personal computers, users can notice thrashing and handle it themselves :

Typically, just buy more memory Or, manage balance set by hand

Thrashing was a bigger issue for timesharing machines with dozens or hundreds of users : Why should I stop my processes just so you can make progress ? System had to handle thrashing automatically. Technology changes make it unreasonable to operate machines in a range where memory is even slightly overcommitted; better to just buy more memory.

#### **Caching**

A cache keeps a subset of a data set in a more accessible but space-limited location. Caches are everywhere in systems, such as, web proxy servers make downloads faster and cheaper, web browser stores downloaded files, registers are a cache for L1 cache which is cache for L2 cache, etc..

The main goal of caching is minimize cache miss rate. In the context of paging, it is minimizing page fault rate. It requires a good algorithm.

We create caches because :

- a. There is not enough fast memory to hold everything we need
- b. Memory that is large enough is too slow
- c. Performance metric for all caches is EAT (Effective Access Time). Goal is to make overall performance close to cache memory performance.

- d. By taking advantage of locality – temporal and spatial
- e. By burying a small number of accesses to slow memory under many, many accesses to fast memory

**9.10 Check Your Progress :**

1. A page fault occurs when
  - (a) The deadlock happens
  - (b) The segmentaion starts
  - (c) The page is found in the memory
  - (d) The page is not found in the memory
2. Bringing a page into memory only when it is needed, this mechanism is called
  - (a) Deadlock
  - (b) Page fault
  - (c) Inactive paging
  - (d) Demand paging
3. Bringing a process from memory to disk to allow space for other processes is called
  - (a) Swapping
  - (b) Demand paging
  - (c) Deadlock
  - (d) Page fault
4. Which of the following memory allocation scheme suffers from external fragmentaion ?
  - (a) Segmentation
  - (b) Demand paging
  - (c) Swapping
  - (d) Paging
5. Page fault frequency in an operating system is reduced when the
  - (a) Processes tend to be of an equal ration of the I/O-bound and CPU-bound
  - (b) Size of pages is increased
  - (c) Locality of references is applicable to the process
  - (d) Processes tend to be CPU-bound
6. What is demand paging ?
  - (a) A policy for determining which page to replace.
  - (b) Loading a page into memory only on a page-fault.
  - (c) Starting a process with all of its pages resident in physical memory.
  - (d) Discarding the least-recently-used (LRU) page in the system.
7. When would you recommend using an inverted page table ?
  - (a) When the maximum amount of physical memory is much less than the maximum logical address space.
  - (b) When the maximum amount of physical memory is much greater than the maximum logical address space.
  - (c) When you want to support page sharing across different address spaces.
  - (d) None of the above

8. Why does the OS want to know the working set for each process ? Circle the best answer and briefly explain your reasoning.
- (a) To determine the best page to replace.
  - (b) To know when memory is over-committed.
  - (c) Assessment : Essay Type Questions

### **9.11 Let Us Sum Up :**

One of the fundamental and complex tasks of an operating system is memory management. Memory management involves treating main memory as a resource to be allocated to and shared among a number of active processes. To use the processor and the I/O facilities efficiently, it is desirable to maintain as many processes in main memory as possible. In addition, it is desirable to free programmers from size restrictions in program development.

The basic tools of memory management are paging and segmentation. With paging, each process is divided into relatively small, fixed-size pages. Segmentation provides for the use of pieces of varying size. It is also possible to combine segmentation and paging in a single memory management scheme.

To use the processor and the I/O facilities efficiently, it is desirable to maintain as many processes in main memory as possible. In addition, it is desirable to free programmers from size restrictions in program development. The way to address both of these concerns is virtual memory. With virtual memory, all address references are logical references that are translated at run time to real addresses. This allows a process to be located anywhere in main memory and for that location to change over time. Virtual memory also allows a process to be broken up into pieces. These pieces need not be contiguously located in main memory during execution and, indeed, it is not even necessary for all of the pieces of the process to be in main memory during execution.

Two basic approaches to providing virtual memory are paging and segmentation. With paging, each process is divided into relatively small, fixed-size pages. Segmentation provides for the use of pieces of varying size. It is also possible to combine segmentation and paging in a single memory management scheme.

A virtual memory management scheme requires both hardware and software support. The hardware support is provided by the processor. The support includes dynamic translation of virtual addresses to physical addresses and the generation of an interrupt when a referenced page or segment is not in main memory.

### **9.12 Check Your Progress : Possible Answers :**

1. (d),      2. (d),      3. (a),      4. (a),  
5. (c),      6. (b),      7. (a),      8. (b)

### **9.13 Assignment :**

- What is the job of Memory Management Unit (MMU) ?
- What is the basic objective of page replacement algorithm ?

**9.14 Activity :**

- Consider the page replacement policies of OPRA, FIFO, and LRU. Which of the following statements are true ? Be careful to notice when the phrase states "better than or equal to" versus "strictly better than".
  - a. OPT always performs better than or equal to LRU.
  - b. OPT always performs strictly better than LRU.
  - c. LRU always performs better than or equal to FIFO.
  - d. LRU always performs strictly better than FIFO.
  - e. OPT with  $n+1$  pages of physical memory always performs better than or equal to OPT with  $n$  pages.
  - f. OPT with  $n+1$  pages of physical memory always performs strictly better than OPT with  $n$  pages.
  - g. FIFO with  $n+1$  pages of physical memory always performs better than or equal to FIFO with  $n$  pages.
  - h. FIFO with  $n+1$  pages of physical memory always performs strictly better than FIFO with  $n$  pages.
  - i. LRU with  $n+1$  pages of physical memory always performs better than or equal to LRU with  $n$  pages.
  - j. LRU with  $n+1$  pages of physical memory always performs strictly better than LRU with  $n$  pages.

**9.15 Case Study :**

- Comparison of various page replacement algorithms

**9.16 Further Reading :**

- Andrew S. Tanenbaum (2008). Modern Operating System. 3rd Edition. Prentice–Hall.
- A Silberschatz, Peter B Galvin, G Gagne (2009). Operating System Concepts. 8th Edition. Wiley.

**UNIT STRUCTURE**

- 10.0 Learning Objectives**
- 10.1 Introduction**
- 10.2 Characteristics of I/O Devices**
- 10.3 Principles of I/O hardware**
- 10.4 Principles of I/O Software**
- 10.5 Disk**
- 10.6 Disk Scheduling Algorithms**
- 10.7 Check Your Progress**
- 10.8 Let Us Sum Up**
- 10.9 Check Your Progress : Possible Answers**
- 10.10 Assignment**
- 10.11 Activity**
- 10.12 Case Study**
- 10.13 Further Reading**

**10.0 Learning Objectives :**

**Upon completion of this unit you should be able to :**

- Sate the Characteristics of I/O Devices
- Describe Principles of I/O hardware
- Define Principles of I/O Software
- Differentiate various Disk Scheduling Algorithms

**10.1 Introduction :**

I/O device management is a very important activity of the operating system. I/O is important for the communication of users to computer. The following are services of the operating system as I/O manager :

- Monitoring all the I/O devices
- Order the I/O devices, capture interrupts and manage bugs related to I/O
- Avail communication channel between I/O devices and all other hardware components

Accessing and storing information is the task of every computer application. A clear and obvious requirement of an operating system is thus, the provision of a convenient, efficient, and robust information handling system. A process can use its address space to store some amount of information. However, three main problems are associated with this method.

One is the adequacy of the space to accommodate all information to be stored by the application as the size of the address space is determined by the size of the virtual address space.

The second problem is the data loss as the process terminates the information kept on its address space is also lost though the information is required to be retained for long period of time.

The third problem is concurrent accessibility of the information by other processes as information saved in one process's address space is accessible only to that process and sometimes there is a need to make this information as whole or part of it available to other processes as well. Solving these problems by separately managing information resulted by a process from its process is a concern of any operating system which is usually done by storing the information on external media in units called files.

The operating system manages naming, structure, access, use, protection and implementation of these files. Thus, component of an operating system and monitors activities related with files is known as a file system which is to be addressed in this section. File management system consists of system utility programs that run as privileged applications concerned with secondary storages.

## **10.2 Characteristics of I/O Devices :**

The I/O devices are varied that operating systems devotes a subsystem to handle the variety. The range of devices on a modern computer system include from mice, keyboards, disk drives, display adapters, USB devices, network connections, audio I/O, printers, special devices for the handicapped, and many special-purpose peripherals. These devices can be roughly categorized as storage, communications, and user-interface. The peripheral devices can communicate with the computer via signals sent over wires or through the air and connect with the computer via ports, e.g. a serial or parallel port. A common set of wires connecting multiple devices is termed as a bus.

Device drivers are modules that can be plugged into an OS to handle a particular device or category of similar devices.

## **10.3 Principles of I/O Hardware :**

**I/O devices have three sections :**

- **I/O devices** : concerned with the way data are handled by the I/O device. There are two types of I/O devices known as blocked and character devices.
- **Blocked devices (such as disks)** : are devices with fixed-size slots having unique addresses and stores data accordingly.. Byte ranges of 512 to 32,768 are the general block size ranges. The ability to read and write each blocks regardless of the other blocks is an important feature of these devices. A disk is the commonly known block device which allows moving the read/write arm any time to any required cylinder position and awaits for the needed block to spin under the head
- **Character devices (such as printers, mouse and NIC)** : The other type of I/O device is the character device. A character device delivers or accepts stream of character, without regard to any block structure. It is not addressable and does not have any seek operation.



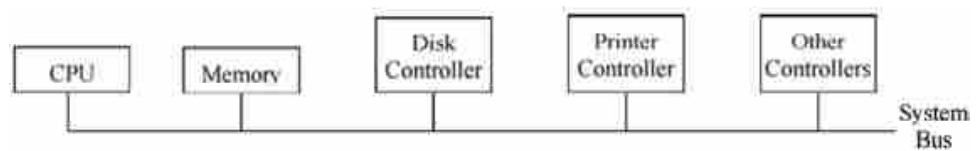

*Figure : Device*

**I/O Unit :**

Indicates the hardware components. There are two major components – Electronic Component (Device controller/Adapter) and the Mechanical Component

Memory-mapped I/O is a technique for communicating with I/O devices.

In this case a certain portion of the processor's address space is mapped to the device, and communications occur by reading and writing directly to/from those memory areas.

**Memory-mapped I/O :**

It is suitable for devices which must move large quantities of data quickly, such as graphics cards.

Memory-mapped I/O can be used either instead of or more often in combination with traditional registers. For example, graphics cards still use registers for control information such as setting the video mode.

A potential problem exists with memory-mapped I/O, if a process is allowed to write directly to the address space used by a memory-mapped I/O device.

**Direct Memory Access (DMA) :**

It is a technique for moving a data directly between main memory and I/O devices without the CPU's intervention.

In the absence of DMA reading from a disk is done with the following steps :

- The controller serially fetches every bit from the block which may have one or more sectors and maintains the whole data in its internal buffer
- The controller then checks for a read error by computing the checksum value of the data
- The controller then sends an interrupt signal to the system
- The OS reads the information found in the controller's buffer, which is the disk block byte by byte or word by word and put it on memory
- Problem : Since the OS controls the loop of reading, it wastes the CPU time. On the other hand, when DMA is used the Device Controller will do the counting and address tracking activities.

The following diagram shows the steps to use DMA :

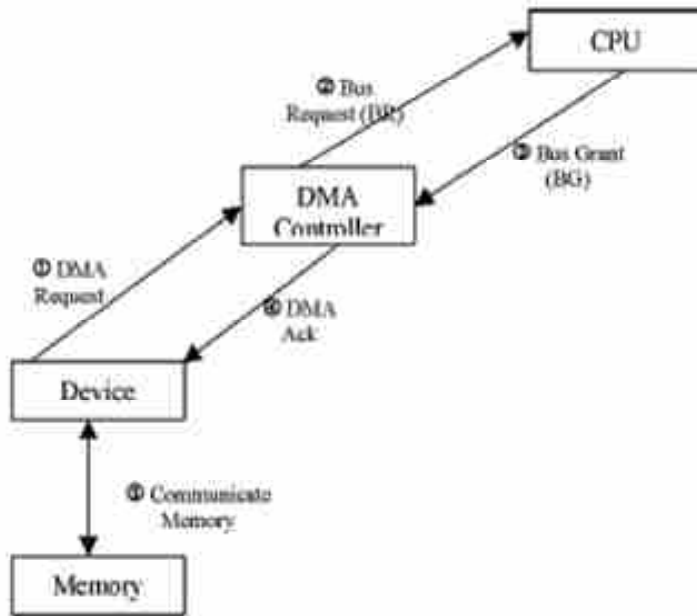

Figure : Steps of DMA between main memory and I/O devices

#### 10.4 Principles of I/O Software :

Layered technique is used

##### Goals and issues of I/O software :

**Device Independence :** It should be possible to write programs that can read files on a floppy disk, on hard disk, or on a CD-ROM, without having to modify the program for each different device types. It is up to the operating system to take care of the problems caused by the fact that these devices are really different.

**Uniform Naming :** file or device names can be any string or number identifier which has no dependency to the file or device, what so ever.

**Error handling :** Broadly speaking, errors need to be dealt with at the device controller level. Most of the errors to be observed are temporary like for instance read errors due to dust spots on the read head and can be solved by performing the needed operation repetitively.

**Transfer :** There are two types of transfer modes – Synchronous (Blocking) and Asynchronous (interrupt –driven). In the case of synchronous transfer the program requesting I/O transfer will be suspended until the transfer is completed. In the case of Asynchronous transfer the CPU starts the transfer and goes off to do something until the interrupt that shows the completion of the transfer arrives.

**Device types :** There are two device types :

**Sharable (such as disk)** devices– accessed by multiple users simultaneously. Nothing is wrong if several users try to open a file from one disk concurrently.

**Dedicated (tape drives)** have to be dedicated to a single user until that user is finished. Having two or more users writing blocks intermixed at random to the same tape will definitely not work

**Layers of I/O software**

The following are the I/O software layers

- Interrupt handler (bottom)
- Device driver
- Device independent OS software
- User-level software (top)

**Interrupt Handler**

Interrupts are undesirable and inevitable situations in life but can be hidden away. One of the methods used to hide interrupts is through blocking all processes with an I/O operation till the I/O is finished and an interrupt happens. The interrupt method will then need to perform various actions and unblock the process which started it.

**Device Driver**

All device – dependent code goes in the device driver

Only one device type, or at most, one group of closely linked devices is handled through each device driver.

Each device driver handles one device type, or at most, one class of closely related devices.

Each controller has one or more device registers used to give it command

The device driver is responsible to give these commands and ensure their proper execution

Thus, the disk driver is the only part of the OS that knows how many registers that disk controller has and what they are used for.

Generally, we can say that a device driver is responsible to get requests from the software, which is device independent, and issue orders for the execution of the requests.

**Steps in carrying out I/O requests :**

- Translate the requests from abstract to concrete terms
- Write the interpreted requests into registers of the device controller's
- The device driver blocks itself until an interrupt comes which awakens or unblocks the driver
- The Device driver starts its operations by first testing for any error on the I/O device
- If no error is identified and everything is properly functioning, data is passed from the driver to the requester software
- If the driver couldn't get any request in the queue, it will move back to block state and waits until a request comes in.

**Device Independent I/O Software**

It is large fraction of I/O software

Services it provides are :

**Uniform interfacing for device drivers** – perform I/O function common to all drives

**Device Naming** – responsible for mapping symbolic devices names onto the proper driver

**Device protection** – secures devices by blocking illegitimate or non-allowed access requests of users

**Providing device-independent block size** – provide uniform block size to higher layers hiding differences in block sizes

**Buffering** : if a user process write half a block, the OS will normally keep the data in buffer until the rest of the data are written. Keyboard inputs that arrive before it is needed also require buffering.

**Storage allocation on block devices** : when a file is created and filled with data, new disk blocks have to be allocated to the file. To perform this allocation, the OS needs a list of free blocks and used some algorithms for allocation

**Allocating and releasing dedicated devices** : The OS is solely responsible to validate any device request and act accordingly by either granting or denying the service.

**Error reporting** : Errors handling, by and large, is done by drivers. Most errors are device dependent. When a device request comes to the driver, it attempts to communicate the requested block certain number of times.

If it is unable to read the block during these times, it stops trying and communicate the requester software the status and finally reports to the caller.

**User Space I/O Software**

A situation where a small portion of the I/O software is outside the OS

In this case, library procedures are used to perform system calls including I/O system calls. For instance, if a C program has a function call `count=write(fd, buffer, n bytes)`; the write procedure from the library will be linked with it and kept in the binary program which will be loaded to memory during execution

The library procedures are also responsible to format the I/O requests

The following is an example how the I/O system works during reading by an application

- **Step 1** : system call to do file reading is passed from the user program.
- **Step 2** : the device-independent software checks the block cache; if the requested block is found there, the device driver will be called.
- **Step 3** : The device driver issue the request to the hardware and the requesting user process will be moved to a block state until the disk operation is finished
- **Step 4** : the disk then generates an interrupt once it finishes the operation
- **Step 5** : The interrupt handler immediately takes over and investigate the interrupt i.e., it first checks for the device currently requiring attention. It then reads the output of the device and unblocks the sleeping process indicating the I/O process is being completed and let the user process continue

The following table 1. shows the I/O system layers along with the major responsibilities of each layer.

*Table 1 : Input Output layers*

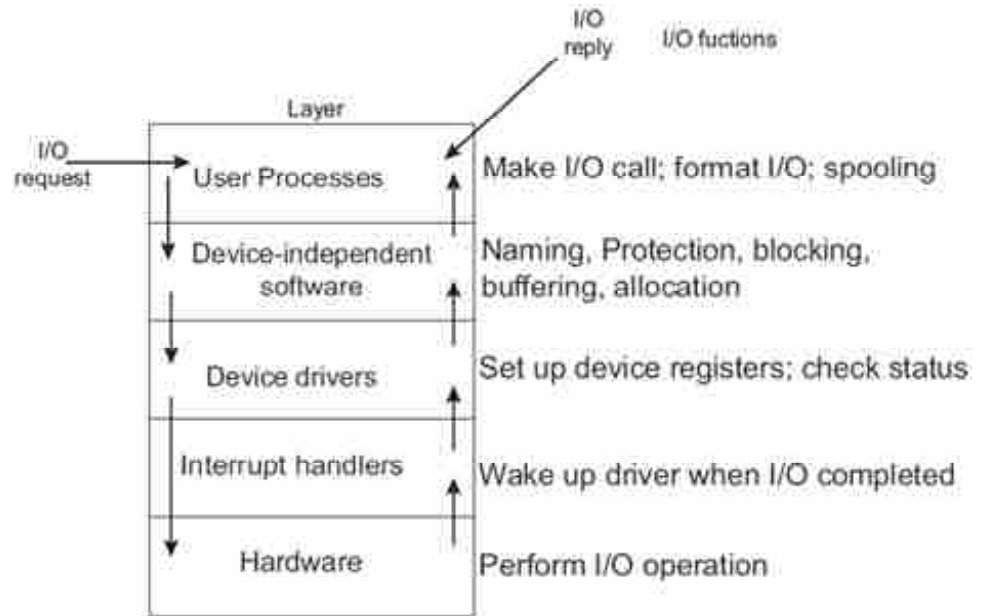

**10.5 Disk :**

All real disks are organized into cylinders, each one containing many tracks. Each of the tracks then will be divided into sectors (equal number of sectors or different number of sectors)

In the case of equal number of sectors

The data density as closer to the center (hub) is high

The speed increases as the read/write moves to the outer tracks

Modern large hard drives have more sectors per track on outer tracks e.g. IDE drives

Many controllers, except floppy disk controllers, are capable of doing a read or write operation on one drive and also seek operation on one or more other drives simultaneously.

**Disk Access Time**

Three factors determine the time required to read or write a disk block :

The seek time (the time to move the arm to the proper cylinder)

The rotational delay (the time for the proper sector to rotate under the head)

**The actual data transfer time**

For most disks, the seek time dominates the other two times, so reducing the mean seek time can improve system performance substantially.

Disk requests can come from processes while the arm is doing a seek operation of another process. A table of waiting disk requests is kept by disk drivers. The table is indexed by cylinder number and pending requests of each cylinder is linked through a linked list that is headed by the table entries.

**10.6 Disk Scheduling Algorithms :**

**Disk Arm Scheduling Algorithm**

The OS maintains queue of requests for each I/O operation and it uses various disk scheduling algorithms. To mention some :

First Come First Served (FCFS) : Accept single request at a time and perform the requests in same order

E.g. Track initial position : 11

Track request : 1, 36, 16, 34, 9, 12

Service order : 1, 36, 16, 34, 9, 12

Arm motion required : 10, 35, 20, 18, 25, 3,

Total = 111 tracks

The simplest and the fairest of all, but it doesn't improve performance

Shortest Seek First (SSF) : It handles the closest (the least disk arm movement) request next, to minimize seek time.

E.g. Track initial position : 11

Track request : 1, 36, 16, 34, 9, 12

Service order : 12, 9, 16, 1, 34, 36

Arm motion required : 1, 3, 7, 15, 33, 2

Total = 61 tracks

**Advantage** : Performance (efficiency), provides better performance

**Disadvantage** : Possibility of starvation (it lacks fairness)

**SCAN (Elevator) Algorithm** :

The disk arm moves in one direction till it couldn't find any more request in that direction, then switches to another direction

Direction bit 1 = up, 0 = down

E.g. Track initial position : 11

Track request : 1, 36, 16, 34, 9, 12

Direction bit : 1

Service order : 12, 16, 34, 36, 9, 1

Disk arm motion : 1, 4, 18, 2, 27, 8

Total = 60 tracks

It provides better service distribution

**C-SCAN (Modified Elevator) Algorithm**

It restricts scanning to one direction only. This is a bit modified version of an elevator algorithm and exhibits smaller variance in response times as it always scan in the same direction. When the highest numbered cylinder with a pending request has been serviced, the arm goes to the lowest-numbered cylinder with a pending request and then continues moving in an upward direction. In effect, the lowest-numbered cylinder is thought of as being just above the highest-numbered cylinder. It reduces the maximum delay experienced by new request.

**RAM Disk**

- A RAM disk has the advantage of having instant access
- Unix support mounted file system but DOS and Windows do not support
- The RAM disk is split up into n blocks each with a size equal to the real disk

- Finally the transfer will be done
- A RAM disk driver may support several areas of memory used as RAM disk

### **Disk Cache**

**Memory cache :** To narrow the distance between the processor and memory.

**Disk cache :** To narrow the distance between the processor/ memory and I/O

It uses a buffer kept in main memory that functions as a cache of disk memory and the rest of the main memory.

It contains a copy of some of the sectors on the disk.

It improves performance (by minimizing block transfer.

Disk memory Design issue :

Data transfer – Memory-to-memory – using shared memory (pointer)

Replacement algorithm – Least Recently used – Least Frequently Used

### **10.7 Check Your Progress :**

1. \_\_\_\_\_ are devices with fixed-size slots having unique addresses and stores data accordingly
2. \_\_\_\_\_ device is not addressable and does not have any seek operation.
3. \_\_\_\_\_ is a technique for moving a data directly between main memory and I/O devices without the CPU's intervention
4. Keyboard inputs that arrive before it is needed require \_\_\_\_\_.

### **10.8 Let Us Sum Up :**

I/O devices are interfaces that communicate users with the computer system. To manage the communication effectively, the operating system uses the I/O subsystem, which has a complete layer of hardware and software.

The I/O function is generally broken up into a number of layers, with lower layers dealing with details that are closer to the physical functions to be performed and higher layers dealing with I/O in a logical and generic fashion. The layering is done in such a way that changes that a specific layer won't affect the other layers.

The aspect of I/O that has the greatest impact on overall system performance is disk I/O. Two of the most widely used approaches to improve disk I/O performance are disk scheduling and the disk cache.

At any time, there may be a queue of requests for I/O on the same disk. It is the object of disk scheduling to satisfy these requests in a way that minimizes the mechanical seek time of the disk and hence improves performance. The physical layout of pending requests plus considerations of locality come into play.

A disk cache is a buffer, usually kept in main memory that functions as a cache of disk blocks between disk memory and the rest of main memory. Because of the principle of locality, the use of a disk cache should substantially reduce the number of block I/O transfers between main memory and disk.

**10.9 Check Your Progress : Possible Answers :**

1. Blocked devices
2. Character
3. Direct Access Memory
4. Buffering

**10.10 Assignment :**

1. Explain the I/O software goals
2. Discuss the two most widely used approaches to improve disk I/O performance
3. What is DMA ? What advantages does it provide to the operating system ?
4. Explain the I/O software goals
5. What is DMA ? What advantages does it provide to the operating system ?

**10.11 Activity :**

- Discuss the two most widely used approaches to improve disk I/O performance

**10.12 Case Study :**

- Study Device Manager available in Control Panel in Windows Operating System

**10.13 Further Reading :**

- Tanenbaum, Modern Operating System, second edition, 2001, Chapter 6
- William Stalling, Operating Systems : Internals and Design Principles, seventh edition, 2011, Chapter 12.



**UNIT STRUCTURE**

- 11.0 Learning Objectives**
- 11.1 Introduction**
- 11.2 File Naming**
- 11.3 File Types**
- 11.4 File Attributes**
- 11.5 File Operations**
- 11.6 Check Your Progress**
- 11.7 Let Us Sum Up**
- 11.8 Check Your Progress : Possible Answers**
- 11.9 Assignment**
- 11.10 Activity**
- 11.11 Case Study**
- 11.12 Further Reading**

**11.0 Learning Objectives :**

**Upon completion of this unit you should be able to :**

- Define : file, file structure, file access, file attributes
- List types of files
- Understand various file operations

**11.1 Introduction :**

A file is a named collection of related information that are treated as a single entity defined by its creator and kept on secondary storage devices that can be accessed by users or applications through file management systems. In this activity, we will discuss how files are handled by the operating system, the naming scheme, access methods, and operations carried out on a file.

File is a contiguous logical storage unit defined by the operating system by abstracting the physical properties of storage devices so that the computer system will be convenient to use by providing a uniform logical view of information storage. File is the most visible aspect of an OS which is used to store and retrieve information from the disk

Files are mapped by the operating system onto physical devices. These storage devices are usually non-volatile making the contents persistent through power failures and system reboots. Files represent both programs and data where data files may be numeric, alphabetic, alphanumeric, or binary. Files can also be either in free form or rigidly formatted. Every file has a name associated with it which is used to interact with. Operating systems provide a layer of system-level software, using system-calls to provide services relating to the provision of files which avoids the need for each application program to manage

its own disk allocation and access. File manager component of the operating system is responsible for the maintenance of files on secondary storages as memory manager is responsible for the maintenance of primary memory. Let's discuss some properties of files from user's point of view.

## 11.2 File Naming :

Files are abstraction mechanism use by a computer system and naming is an important aspect of a good abstraction mechanism. Name is assigned to a file by the creating process at the time of creation which is then used by other processes to communicate with the file after the creating process terminates. A file is named, for the convenience of its human users, and is referred to by its name. A string of eight or more characters is used to label a file in most operating system though digits and some special symbols are allowed in some situations. Some operating systems, like UNIX, make distinctions between uppercase and lowercase file names where as others like MS-DOS do not. A file name has two parts separated by a period.

The first part is the label for the file while the last part is the extension indicating the type of the file and with which the operating system identifies the owner program for that file. Thus, opening the file will start the program assigned to its file extension using the file as a parameter.

### File structure

A file is a sequence of bits, bytes, lines, or records, the meaning of which is defined by the file's creator and user. A file can be structured in several ways among which these three types are common.

### Byte sequence

The file is organized in unstructured sequence of bytes where the operating system is unaware of the file content. Meaning of the bytes is imposed by user programs providing maximum flexibility but minimal support. This structure is advantageous for users who want to define their own semantics on files. UNIX and MS-DOS operating systems use this structure.

### Record sequence

The file is treated as a sequence of internally structured fixed length records. In such a structure, reading from or writing into a file interacts with one record. No systems currently use this method though they were very popular in early times in mainframe computers.

### Tree

The file consists of a tree of records that may differ in length and each having a key parameter in a fixed position in the record which is used to interact with the records. The operating system can add new records to the file deciding the place for the record. The records on the tree are sorted based on the key field which makes searching faster. Large mainframe computers use this structure.

## 11.3 File Types :

Several types of files exist that are supported by an operating system.

**Regular files :** are the most common types of files consisting user information. Regular files may contain ASCII characters which are texts, binary data, non-texts and not readily readable, executable program binaries, program input or output. The contents of such files is structured with no kernel level support

**Directory** : is a binary file consisting of list of files contained in it. These are system files used to manage file system structure which may contain any kind of files, in any combination. . and .. refer to directory itself and its parent directory. The two commands used to manage directories are mkdir, to create a directory, and rmdir, to remove a directory

**Character-special files** : are I/O related files that allows the device drivers to perform their own I/O buffering. These files are used for unbuffered data transfer to and from a device. The files generally have names beginning with r(for raw), such as/dev/rhd0a

**Block-special files** : are files used for modeling disks and other devices that handle I/O in large chunks, known as blocks. These files expect the kernel to perform buffering for them. They generally have names without the r, such as /dev/sd0a.

**File access**

Files can be accessed either sequentially or randomly. In a sequential file access, a system reads the bytes in order starting from the beginning without skipping any in between. Rewinding or backing up is possible but with limited accuracy and slow performance. Such files were available during the magnetic tape era. In a random file access, a system can traverse the file directly in any order. Bytes or records can be read out of order and access is based on key rather than position. Disks made possible this random accessibility of files. These are essential for database systems.

**11.4 File Attributes :**

Attributes of a file are extra information associated with files in addition to name and data. Some of these attributes are listed in table.1 below

*Table 1 : Attributes of files and their description*

Attribute	Description
Protection	Who and how a file can be accessed
Password	The key to access a file
Creator	ID of the user who created the file
Owner	The current owner of a file
Read-only flag	0 for read/write, 1 for read only
Hidden-file flag	0 for normal, 1 for not in the display list
System file flag	0 for normal, 1 for system files
Archive flag	0 for backed up, 1 for a need to backup
ASCII/Binary flag	0 for ASCII, 1 for binary
Random access flag	0 for sequential, 1 for random
Temporary flag	0 for normal, 1 for delete on process exit
Lock flag	Non-zero for locked, 0 for unlocked
Record length	Number of bytes in a record
Key position	Offsets of the key within each record

Key length	Number of bytes in a key field
Creation time	Date and time of file creation
Time of last access	Date and time of the file's last access
Time of last change	Date and time of the file's last update
Current size	Number of bytes in the file
Maximum size	Number of bytes the file may grow to

### 11.5 File Operations :

Storage and retrieval of files is handled with different types of operations provided by a system. The operating system can provide system calls to create, write, read, reposition, delete, and truncate files. Some of the operations defined on files are :

**Create file :** Create a new file of size zero or with no data. The attributes are set by the environment in which the file is created. The task of this system call is to inform about the file and define the attributes it has

**Open file :** used to establish a logical connection between process and file. It fetches the attributes and list of disk addresses into main memory for rapid access during subsequent calls

**Write :** Transfer the memory into a logical record starting at current position in file. This would increase the size of the file if current position is the end of file, or may overwrite and cause content loss if current position is found at the center of the file

**Read :** Transfer the logical record starting at current position in file to memory starting at buffer known as input buffer. It is the task of the caller to indicate the amount of data to be read and where to read

**Close :** Disconnects file from the current process. The file will not be accessible to the process after close

**Delete :** removing a file when no more needed so that some disk space is utilized.

**Append :** used to perform restricted write operation by adding data at the end of an existing file

**Seek :** used to specify from where a data should be accessed in a randomly accessible file by repositioning the current-file-position pointer to a given value. In addition to these basic operations, there are also common operations defined on files such as rename, copy, set and get attributes, etc. most of these operations require searching for a named file in the directory of files causing continuous search.

To overcome this continuous searching, most systems perform a call to open operation before the file is first brought active.

### 11.6 Check Your Progress :

- \_\_\_\_\_ can provide system calls to create, write, read, reposition, delete, and truncate files
- \_\_\_\_\_ of a file are extra information associated with files in addition to name and data

3. In a \_\_\_\_\_ file access, a system reads the bytes in order starting from the beginning without skipping any in between.
4. In a \_\_\_\_\_ file access, a system can traverse the file directly in any order.
5. \_\_\_\_\_ operating system make distinctions between uppercase and lowercase file names
6. \_\_\_\_\_ is a binary file consisting of list of files contained in it.
7. \_\_\_\_\_ files are used for unbuffered data transfer to and from a device

### **11.7 Let Us Sum Up :**

When a process has information to be maintained, it keeps it in its address space which causes three main problems. Storage capacity of a system is restricted to the size of available virtual memory which may not be enough for applications involving large data; the virtual memory is volatile which may not be good for long term storage and information need not be dependent upon process as there might be a need to modify that data by different processes. To overcome these limitations, long term information storage, file, is essential. A file is a named collection of related information defined by its creator. It is an abstraction used by the kernel to represent and organize the system's non-volatile storage resources, including hard disks, CD-ROMs, and optical disks. File system is part of the operating system that manages files. Every file has a name attribute associated with it which is used to communicate with it. file names have a different extension they end with according to the file type. A file can represent a program or data and can support free form or rigid form. A file can be structured in byte, record or tree form and can be accessed either sequentially or randomly. The operating system uses several types of operations, through system calls, to interact with files.

### **11.8 Check Your Progress : Possible Answers :**

1. The operating system
2. Attributes
3. Sequential
4. Random
5. UNIX
6. Directory
7. Character-special files

### **11.9 Assignment :**

- a. Discuss in detail three file attributes.
- b. What is the difference between random access and sequential access ?
- c. What are the extensions found in file name used for ?

### **11.10 Activity :**

- Identify different types of files exists on your computer / laptop
- Discuss the problems encountered by a process when keeping information in its address space

### **11.11 Case Study :**

- Study media files supported by Windows Media Player

**11.12 Further Reading :**

- Tanenbaum, Modern Operating System, second edition, 2001
- William Stalling, Operating Systems : Internals and Design Principles, seventh edition, 2011

**UNIT STRUCTURE**

- 12.0 Learning Objectives
- 12.1 Introduction
- 12.2 File Organization
- 12.3 Directory Organization
- 12.4 File System Hierarchy
- 12.5 Check Your Progress
- 12.6 Let Us Sum Up
- 12.7 Check Your Progress : Possible Answers
- 12.8 Assignment
- 12.9 Activity
- 12.10 Case Study
- 12.11 Further Reading

**12.0 Learning Objectives :**

Upon completion of this unit you should be able to :

- Define Directories
- Understand types of directory organizations
- List various directory operations
- Explain file system hierarchy

**12.1 Introduction :**

Directory is collection of nodes that contains information about files. Directories shall be logically organized to achieve efficiency, facilitate convenient naming, and allow file grouping. This activity covers overview of file directory, organization of directories and operations that can be carried out on directories by users or applications. A general purpose computer maintains thousands and millions of files on secondary storages.

An entire space of a secondary storage device may be used to store a file or only its portion. Directory is a means provided by the file system to keep track of files. In most systems, directories, also known as folders, are files themselves owned by the operating system and have their own organization, properties and operations. They provide mapping between file names and the files themselves. Directory contains a number of entries about files such as attributes, location, ownership etc.. The directory may keep the attributes of a file within itself, like a table, or may keep them elsewhere and access them through a pointer. In opening a file, the OS puts all the attributes in main memory for subsequent usage

**12.2 File Organization :**

Files can be organized in a single-level directory structure or multi-level directory structure. In a single level directory structure, all the files in a system are kept in one directory, which may also be referred as root directory. This organization scheme is known to be simple and results in fast file search. However, it encounters a problem when the number of files to be maintained increases or when used in a multi-user systems as names of each file is required to be unique. If two or more users create files with same name, this uniqueness requirement is overridden and in such cases the last file created overwrites the previous one causing the first file being replaced with another file of same name.

In a two-level directory structure, a private user level directory is assigned for each user which elevates the naming conflicts encountered in a single-level directory structure. The basic implementation of this organization requires all users to access only their own directory. But with little modification, it can extend to allow users to also access other user's directories through some notification mechanism. In this organization, it is possible to provide same names for files of different user. The system implicitly knows where to search for a file when asked to open a file since each user is associated with a private directory. This organization also has its own drawbacks. It creates total isolation between users which is not required in systems where processes share and exchange data. It may also not be satisfactory if users have many files. Figure 1 and figure 2 below shows the single-level and two-level directory organizations respectively.

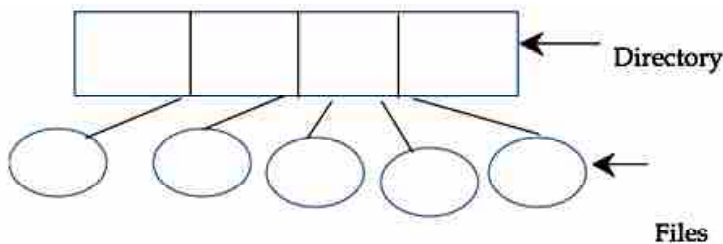

**Fig. 1 : Single Level Directory Organization**

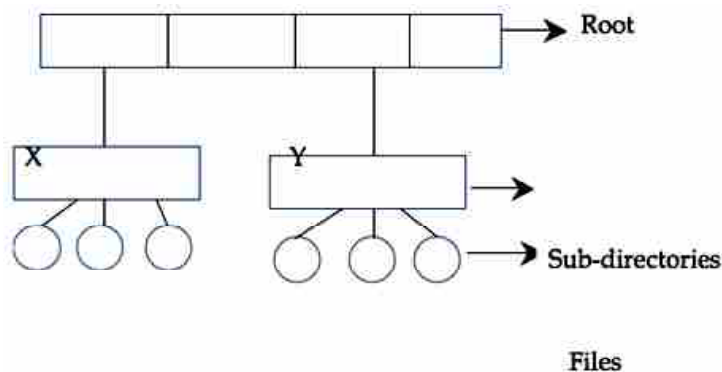

**Fig. 2 : Two Level Directory Organization**

Organizing files in a two level directory system does not suffice for systems with several files and where a logical organization is required. A general hierarchical structure of several directories needs to be allowed for each user where files are organized in their natural categorical manner by extending the two level directory organizations. This hierarchical organization of directories is called tree structure where the top directory is the root sitting at the top



of the tree and all directories spring out of the root allowing logical grouping of files. Every process can have its own working directory also referred as current directory to avoid affecting other processes. A directory or sub-directory has a set of files or other directories inside.

When a process references a file, it will be searched in the current directory which contains files which are currently active. Otherwise, if user needs to access a file not residing in the current directory, file name should be specified through path names or the current directory should be set to the directory holding the desired file through a system call which takes the name of the directory as parameter. Path names are conventions used to specify a file in the tree hierarchy of directories. A hierarchy starts at the directory/, known as the root directory.

A path name is then made up of a list of directories crossed to reach the desired file followed by the file name itself. Two kinds of path name specifications exist. An absolute path name is a unique name that always start from the root directory and extends to a file. The part separator in directories (/ for UNIX and \ for Windows) is the first character of any absolute path name. example /usr/books/os in UNIX and \usr\books\os in windows. A relative path name is a name which does not begin with the root directory name. This path name is specified relatively to the current directory of a process. for instance if the working directory for a process is /usr/books, then the previous file with absolute path name of /usr/books/os can be communicated as os. A relative path name is more convenient than the absolute form and achieves the same effect.

The advantage of a tree directory structure is its efficient searching and grouping capability where users are allowed to define their own subdirectories by enforcing structures on their files.

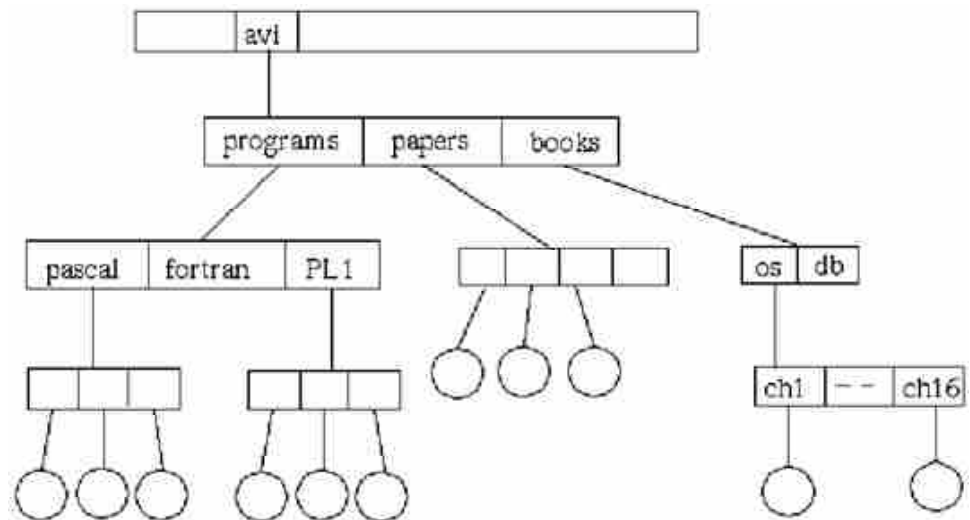

*Fig. 3 : Tree Structure of Directories*

### **12.3 Directory Organization :**

There are various system calls associated with directory management. Let's discuss some of these operations defined on directories.

**Create :** is an operation used to create a new and empty directory except for the two special components that are automatically included by a hierarchical directory structure supporting systems. These are the dot (.) and dot dot (..)

that refers to the current directory and its parent respectively. The mkdir command is used in both UNIX and MS-DOS to create a directory.

**Delete** : a call used to remove an existing directory from a system. A directory with no component (except the dot and dot dot) can be deleted from a system. The rmdir command does the magic in UNIX and MS-DOS.

**Open directory** : used to open a directory for reading through an opendir system call.

**Close directory** : calls the closedir operation and is used to exit a directory that was opened for reading to free space on internal table

**Read directory** : done by the readdir system call to access an opened directory by returning the next entry of the directory

**Rename** : change the previous directory name

**Link** : is creation of pointers to other files or directories so that same file can appear in multiple directories enabling file sharing. The system call generates a link from an existing file to a given path taking an existing file name and a path name. A file may have any number of links but all will not affect the attributes of the file. A link can be either a hard link done by the link() system call, where links are made only to existing files in one file system not across file systems and requires all links to the file must be removed before the file itself is removed , or a symbolic link done by the symlink() system call, which points to another named file spanning across file systems. The original file can be removed without affecting the links.

**Unlink** : used to remove a directory entry. If the file being removed is present in one directory, it is removed from the file system. Whereas, if the file being removed is present in multiple directories, only the path name specified is removed; others remain. The rm/rmdir user commands and the unlink() system call can be used to unlink a file.

#### **12.4 File System Hierarchy :**

So far, our discussion has focused mainly on file systems as viewed by end users. The kernel of an operating system has also its own perception of files that will be addressed in this activity. Here the issue is about file system implementation dealing with storage of files and directories, disk space management and making everything work effectively and reliably.

Using disks to efficiently store, search and read data on disks is made possible through file systems. Two quite different design issues are faced by a file system : defining the file system interface to the user through defining a file with its attributes, the operations allowed on a file, and the directory structure for organizing files and defining algorithms and data structures to plot the logical file system onto the physical secondary-storage devices. The file system is generally structured with several levels making a layered design used to abstract the lower level details associated with it from the higher level components but each high level layer making use of the lower level layers functions to produce new features. Figure 4 below shows this hierarchy of a file system design.

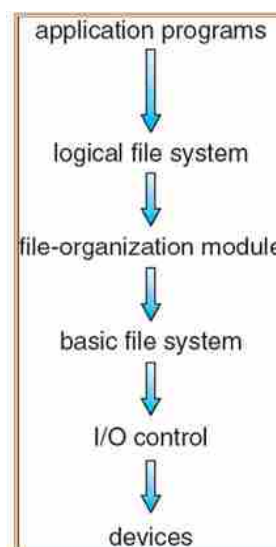

**Fig. 4 : File System Hierarchy**

The top level, the application programs, are codes making file requests and handle the content of the files as they have knowledge of the file's internal structure. The logical file system layer is responsible for managing the metadata of the file system, not the data in the files. It also manages directory structures and maintains file structures through a file control block that contains information about the file. The file-organization module layer translates logical block addresses to physical ones as logical addresses of files do not match to physical addresses. This layer also has free space managers that tracks and inform it about free blocks.

The basic file system layer makes generic requests to appropriate device drivers to read or write the physical blocks on the disk. Memory buffers and caches where file systems and data blocks reside are also managed by this layer.

The I/O control layer presents device drivers and interrupts handlers used to transfer information between the device and main memory. It generally interfaces with the hardware devices and handles different interrupts associated with the I/O devices.

The last layer is the device layer which presents the actual devices like disks, tapes, etc. a new file is created through a call made by application program to logical file system which, as been mentioned, knows about directory structures and defines a new file control block to the file. The system then uploads the indicated directory into memory and update its content with the new file name and file control block and finally return it back to the disk.

The file organization module is then called by the logical file system so that the directory I/O is mapped to a disk block numbers which is then used by basic file system and I/O control components concluding a file creation call. I/O can then be performed on this file once it is opened for such operations. All modern operating systems have adopted the hierarchical directory model to represent collections of files as they support more than one file system both removable-media based and disk based file systems.

In a layered file system structure, code reusability is enhanced and duplication of codes highly reduced as the I/O control and also the basic file system modules can be used by more than one file system each then defining their own logical file system and file organization module. However, layering also has its own drawback which is performance overhead on the operating system. Thus, decisions about hierarchical file system structure are a serious design issue that needs to be addressed when new systems are brought.

### **12.5 Check Your Progress :**

1. \_\_\_\_\_ is collection of nodes that contains information about files.
2. The advantage of a \_\_\_\_\_ directory structure is its efficient searching and grouping capability
3. In a \_\_\_\_\_ directory structure, all the files in a system are kept in one directory, which may also be referred as root directory
4. \_\_\_\_\_ path name is a unique name that always start from the root directory and extends to a file.
5. \_\_\_\_\_ path name is a name which does not begin with the root directory name.

### **12.6 Let Us Sum Up :**

A directory is a means through which files are organized and managed by a file system. A single directory may contain all available files in a system or a two level directory organization can be used where by each user is assigned its own directory. A logical structuring of files in a system can be achieved through a tree like hierarchical organization of directories where users can create their own subdirectories and impose different structures to their files. A tree structure has an efficient search and grouping advantages to users. Referencing of files in such organizations is done through path names which can be specified either absolutely or relatively in reference to user's current directory. A number of operations can be carried out on directories either through system calls or user commands.

In this unit, files are discussed from the operating system's kernel perspective. The operating system has a file management system by which secondary storage devices are utilized to maintain data permanently through files. The file system has a hierarchical arrangement so that lower level technical details of how files are handled by the system is abstracted from the higher level users or applications. This hierarchical arrangement of file defines six different components with a distinct operation to handle. Though hierarchical arrangement of these components reduces code duplication by making some of the components used in several file systems, performance overhead resulted because of it should not also be neglected which requires a trade-off to be made between these two choices while designing a system.

### **12.7 Check Your Progress : Possible Answers :**

1. Directory
2. Tree
3. Single Level
4. An absolute
5. A relative

### **12.8 Assessment :**

- What are the limitations of a two-level directory organization ?
- What does a link operation define on directories ?
- What is the difference between absolute path and relative path of a file ?
- Discuss what a file system is
- What are the different layers found in a file system hierarchy ?

### **12.9 Activity :**

- What advantage has the hierarchical arrangement of a file system ?
- What are the two design issues related with file systems ?

### **12.10 Case Study :**

- Study Windows File System

### **12.11 Further Reading :**

- Tanenbaum, Modern Operating System, second edition, 2001
- William Stallings, Operating Systems : Internals and Design Principles, seventh edition, 2011

# *FILE SYSTEM IMPLEMENTATION*

## UNIT STRUCTURE

- 13.0 Learning Objectives
- 13.1 Introduction
- 13.2 File System Layout
- 13.3 File Storage Allocation Methods
- 13.4 Directory Implementation
- 13.5 File Sharing
- 13.6 Disk Space Management
- 13.7 File System Reliability
- 13.8 File System Consistency
- 13.9 File System Performance
- 13.10 Check Your Progress
- 13.11 Let Us Sum Up
- 13.12 Check Your Progress : Possible Answers
- 13.13 Assignment
- 13.14 Activity
- 13.15 Case Study
- 13.16 Further Reading

### 13.0 Learning Objectives :

Upon completion of this unit you should be able to :

- Define MBR
- Understand file storage allocation methods
- List methods of directory implementation
- Explain file sharing, file system consistency, file system reliability

### 13.1 Introduction :

In the previous unit, we tried to point out file system from the user's view as well as kernel's view. Let's now move our discussion to the structures and operations used to implement file systems. In this activity, files and directory storages, disk space management, as well as efficient and reliable file management system implementations will be examined.

### 13.2 File System Layout :

File systems are stored permanently on secondary storage devices such as disks. These disks can be used in their entirety or partitioned into partitions whose layout differs between file systems and each maintains different file systems. On disk, the file system contains information about how an operating system is to be booted, the total number of blocks, the number and location of free blocks, the directory structure, and individual files.

The Master Boot Record (MBR) which is found at sector 0 of a disk contains information used to boot an operating system from that disk. The end of the MBR is the partition table which gives the start and ending address of each partition. When the MBR executes, the first thing it does is locating an active partition among the available partitions by reading it to its boot block in UNIX and partition boot sector in windows , the first block, which contains a bootable operating system that is loaded when programs on this block execute. A super block, also termed as volume control block is another component of a file system which consists key parameters of the file system such as available blocks in a partition, size of each block, free block count, etc... and is loaded to memory either on system boot or on first use of the file system. A free space management attribute, nodes describing the files, root directory of the system and all the other directories found in the file system are also some other components of a file system. The general file system layout is shown in figure 1 below.

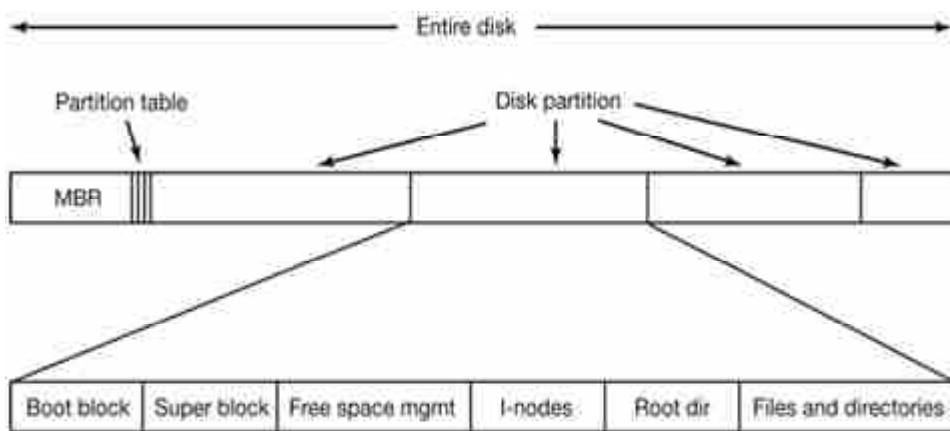

**Fig. 1 : A File System Layout**

The most important thing to consider during file implementation is making associations between files and blocks associated with each file system. To achieve this, various allocation methods are used that differs among different operating systems. Three general methods of allocating storage on hard disks are available.

### **13.3 File Storage Allocation Methods :**

**Contiguous allocation :** In contiguous space allocation, each file occupies a set of contiguous blocks on the disk by laying down the entire file on contiguous sectors of the disk. Disk addresses (or sector addresses) are defined linearly on the disk. Therefore disk address 0 would map to cylinder 0, head 0, sector 0, disk address 1 would map to cylinder 0, head 0, sector 1, disk address 2 would map to cylinder 0, head 0, sector 2 and so on. Then logical block 0 is stored in disk address 0, logical block 1 is stored in disk address 1, and so on. This method has a simple implementation as keeping track of files only requires memorizing of two numbers : first block's disk address and number of blocks in a file with which any other block can be found through addition. Moreover, only a single seek operation is used to read the whole file from the disk which enhances system's read performance. Thus when accessing files that have been stored contiguously, the seek time and search time is greatly minimized. The main disadvantage of such method is the difficulty to obtain such contiguous locations especially when the file to be stored is large in size. Such files cannot be expanded unless there is empty

space available immediately following it. If there is not enough room, the entire file must be recopied to a larger section of the disk every time records are added. There is also the problem of external fragmentation as disks are not compacted the moment a file is removed leaving holes in between files and causing this fragmentation problem.

**Linked list allocation :** solves all the problems of contiguous allocation by storing each file as a linked list of disk blocks which may be stored at any particular disk address and using the first word of each block as a pointer to the next one,. The entry in the directory for a file will consist of a pointer to the disk address for the first block (or record) in the file and the last block (or record) in the file. The first block will contain a pointer to the second block, which in turn will contain a pointer to the third block and so on. There's no external fragmentation since each request is for one block. This method can only be effectively used for sequential files. Linked allocation however does not permit direct access since it is necessary to follow each block one at a time in order to locate a required block causing extremely slow access. Pointers also use up space in each block and reliability is not high because any loss of a pointer results in loses the rest of the file. These problems can be solved through placing the pointer words of each block in a table known as the File Allocation Table (FAT) in memory. Using a separate disk area to hold the links frees the entire block for data and also solves the slow access in random access though this table needs be available in memory all the time. A FAT file system is used by MS-DOS

**I-nodes :** a data structure called an index node (i-node) listing the attributes and disk addresses of the file's blocks is associated with each file in this method. The I-node is created at the time of file system creation (disk partition) and remains always in the same position on the file system. I-node table size determines the maximum number of files, including directories, special files, and links that can be stored into the files system.

Each file uses an index block on disk to contain addresses of other disk blocks used by the file. When the  $i$ th block is written, the address of a free block is placed at the  $i$ th position in the index block. Such method requires the i-node to be in memory only when the file is open which solves the limitations of the FAT system by reducing the space requirement. An I-node creates an array of size proportional to the maximum number of concurrently accessed files which differs it from the FAT of linked list allocation system which has a proportional size to the disk size growing linearly as the disk grows. The i-node also has its limitation if each node is of fixed number of disk addresses and can't address when files exceed this limitation.

#### **13.4 Directory Implementation :**

In this topic, the focus is on how directories are implemented within a system and what the concerns are in relation with directories. In order to read a file, it needs be opened. During file opening, a user provides a path name which is an ASCII value to be mapped and used by the operating system to locate the directory entry which gives information used to track disk blocks associated with that file. The information may be the whole file's disk address, for adjacent allocation, the number of the first block, for linked list allocation or the number of the i-node. Every file system also needs to maintain file attributes. File attributes are properties of files such as its creation time, owner,

etc that needs to be stored. It is possible to maintain these attributes in a directory entry which is how most systems handle the issue.

A directory is defined with fixed size entries per each file and holds the file name, structure of the file attributes and disk addresses specifying locations of disk blocks. It is also possible to store this information in the i-nodes for systems with i-node space allocation.

A file name can be of fixed length with a pre-defined number of characters constituting the name or variable length which doesn't restrict the character numbers in a file name. These variant of file names can be implemented by setting a limit on file names length, commonly 255 characters. This approach has simple implementations but wastes directory space as few files have such lengthy names.

Another possibility can be considering a variant entry size in directories containing the length of the entry itself, some file attributes and the file name. Every file name is expected to fill out an integral number of words so that the next directory entry is started on a word boundary. Figure 7.6 depicts this method of handling variable length file names. During file removal process,, a variable size break is introduced in the directory which may not be enough for a newly coming file. A page fault can also occur while reading a file name as directories may cover multiple pages of memory.

Making constant size directory entries and keeping all the file names together in a heap found at the end of the directory can also be another solution towards handling the variant long file names as. This method solves the fitting into a freed space problem encountered in the previous scheme. But heap management should be performed and there is no guarantee of page fault avoidance.

In all these directory implementations, a linear list of directory entries with pointers to the data blocks is used which makes searching for files linear. This method is simple to program but time-consuming to execute. Creating a new file, for instance, requires searching the directory to be sure that no existing file has the same name and the new entry is added at the end of the directory. File deletion also requires searching the directory for the named file and then release the space allocated to it. This linear arrangement of entries results in a slow search operation especially when the directory is too long. Caching results of a search or using a hash table of each directory can be used to speed up the search. The cache is first checked for the file name before starting the search avoiding the long lookup if it is found in the cache.

Through hash table method, file name is entered by representing it with value between 0 and  $n-1$  by performing division by  $n$  and taking the remainder of the division or by adding the words in the file name and dividing it by  $n$  where  $n$  is the size of the hash table. This hash code is inspected to determine if it is used or not. If the slot is occupied, a linked list headed at that table entry is created that threads through all entries with same hash table. But if the slot is unexploited, a pointer to the file entry that follows the hash table will be kept there. Searching for a file is done by hashing the file name and select a hash table entry and checking if the file is present in all the chain entries. If the file is not found, the file is not available in the directory. While searching is improved in hash table implementation, administration complexity is also inevitable



### **13.5 File Sharing :**

In a multiuser system, there is a frequent need to share files among users which demands the need to present common files within different directories of multiple users at a time. Two important issues needs to be addressed in association with file sharing. These are access rights and simultaneous access of files. One thing to note is the difference between shared file (or directory) and two copies of the file. With two copies of a file, the copy is accessible by each user not the original, and if one user updates the file, the changes will not appear in the other's copy. With a shared file, however, only one actual file exists, making immediately visible any changes made by one person to the other. Sharing is particularly important for subdirectories as a newly created file by one user will automatically appear in all the shared subdirectories. Several implementation possibilities are there for shared files.

A common way, exemplified by many of the UNIX systems, is to create a new directory entry called a link which is effectively a pointer to another file or subdirectory. When a shared file or directory exists, the system creates a new file of type link specifying the path name of the file it is linked to. Links are easily identified by their format in the directory entry (or by having a special type on systems that support types) and are effectively indirect pointers which are neglected by the operating system when traversing directory trees and thus referred as symbolic links. The advantage of symbolic link implementation is their use to link to files over networks through the network address specification of the machine that holds the shared file as link. But the problem with this implementation is the resulting of two or more paths of same file. Another problem associated with the symbolic link implementation is the extra overhead incurred as a result of parsing the path component wise through extra disc accesses.

Another shared file implementation approach is through simple duplication of all information about the shared files in both directories resulting in identical and non-distinguishable entries which is different from the link implementation discussed earlier. Consistency maintenance is a major problem in this implementation during file modifications as the changed content is visible only to the user making the changes which brings down the sharing concept.

### **13.6 Disk Space Management :**

In order to maintain files on disks, a space should be allocated and the system needs to keep track of free spaces to be allocated. An n byte file can be stored on disks using either of the two possibilities. These are allocating n successive bytes of a disk space or breaking down the file into several fixed size non-successive blocks. As contiguous allocation has its own limitation which we had seen earlier, most systems prefer the non-adjacent fixed size block partitioning of files. The question, however, is the size of the block as making it too large wastes the total disk space while too small results files to have several number of blocks. In general, a block can be allocated sector, track or cylinder sizes. Having blocks of cylinder size for every file lack resource utilization as small files don't consume all the space. However, access time which is directly dependent on the seek time and rotational delay of the r/w head, is enhanced with larger block sizes as the data rate is directly proportional to block size. If a small size block is defined, which makes the file to be sliced up into several blocks, a space utilization is increased in a

block but also causes a longer access time. Overall, blocks of larger size tend to have less space utilization but better performance while blocks of small size have better space utilization but poor performance. Keeping track of free blocks is another concern in disk space management after the disk size is being defined. Since disk space is limited, we need to reuse the space from deleted files for new files, if possible. A free space list is maintained by the system to keep track of free disk space which records all free disk blocks which are not allocated to some file or directory. During file creation, the free space list is looked up for the needed amount of space and allocate this block for the new file which will then remove it from the list and when a file is removed, its disk space is added to the free space list. This free block space management is carried out by bitmap and linked list of blocks.

**Bitmap** : an n bit bitmap is defined for an n block disk where allocated blocks indicated with a bit value 0 and free blocks with bit value 1 in the bitmap. A bitmap requires less space as the blocks are represented by bits. This method is relatively simple and is efficient in finding free blocks though different bit-manipulation instructions that can be used effectively for that purpose. One technique for finding the first free block on a system that uses a bit-vector to allocate disk space is to sequentially check each word in the bit map to see whether that value is not 0. The first non-0 word is scanned for the first 1 bit, which is the location of the first free block.

**Linked list** : all free disk space blocks are linked together and a pointer to the first free block is kept in a special location on the disk and caching it in memory. During file creation, the blocks needed are captured from the blocks of pointers that are read from the disk when file creation ends.. Deleting a file adds the freed space to the block of pointers in memory which is written to disk. There are cases where this method is not efficient due to unnecessary disk I/O. traversing the list requires reading each block which requires a substantial I/O time though it is done less frequently as the first free block is always allocated to a file that needs a space. The FAT method's allocation data structure has this free-block accounting which avoids the need for a separate method of free block management.

**Disk quotas** : In multiuser operating systems, there is a need to limit the maximum allotment of files and blocks for each user to prevent users from monopolizing the disk space and the system assures no user exceeds the limit set. Among the attributes of a file is the owner entry specifying by whom the file is owned and this will be reviewed when a file is opened to charge the owner for any increase in the file's size. Another table defining the quota of each user with a currently open file is also maintained by the system whose records are written back to the quota file once the opened files are closed. This table has a pointer to the quota file of the user which is used to check the limits of the user every time a block is added to the opened file resulting in error if the limit is exceeded.

### **13.7 File System Reliability :**

If your computer is damaged by an accident, it is possible to replace the damaged component with minimal cost. However, if a file in a computer is damaged or lost, recovering from the loss would be expensive, if not impossible, which is the case most of the time. File damage can happen due to physical or logical reasons and we need to have an efficient and optimal

file system that can protect the information from logical damages. In this activity, issues involved in protecting the file system and reliability concerns will be discussed.

### **Backups**

Taking backups is an important task which mostly is overlooked by most users. Backing up is a process of saving files on external devices, usually tapes so that a system can use it to recover from a disaster when encountered. Backing up takes a long time and large storage space which requires to be done efficiently. Considerations need to be made as to whether the entire file system or part of it should be backed up. Mostly, it is desirable to take backups of directories and files that can't be found elsewhere. For instance, program files need not be backed up as it is possible to reinstall them from the manufacturer provided devices. Similarly, temporary files shouldn't also be included in the backup contents. Moreover, taking a backup of unchanged files and directories since the last backup is also a waste of space and time. An incremental dump is a means by which a backup of whole file is taken periodically and makes a daily backup of only the changed components since the last backup and even more effective is to take backups of those files changed since they were last dumped. Recovering is made complex in this incremental dump though it reduces recovery time.

When a system tries to recover using this dump file, the most current full backup is restored first after which comes all incremental backups but in reverse order. If the backup file is too much, compression algorithms can be used to compress the backup before saving it onto the tape which will then be decompressed by decompression algorithms at the recovery. If files and directories are active while taking backups, inconsistent results might be obtained. So making systems offline while backup or using algorithms to take rapid snapshots of file systems can be used to avoid such situations. Two dumping mechanisms are used to backup files. A physical dump writes all the disk blocks starting at block 0 of the disk till the end. It will not leave out empty disk blocks and bad blocks which may result in an infinite disk read errors during the backup process. This backup is known for its simplicity and great speed while making unselected backup, incrementally dumping and individual file restores upon request are its disadvantages.

A logical dump is the most commonly used backup taking system used which starts writing from selected files and directories and recursively backs up all files that had been changed since the last backup or system installation to a tape making recovery of a selected file or directory simpler. During recovery, an empty file system is created onto which the most recent full dump will be stored and the system makes use of this file to restore the directories and files in it. Then, if there exists a dump performed incrementally after the full one, the system restores them by performing the same task as with the full dump recovery.

A logical dump has some critical issues that we need to be aware of. One, it doesn't save the free disk block list and the system needs to reconstruct this block after restore is performed. Second, for a linked file, the system should make sure this file is restored only once. Thirdly, files with holes inside, the hole should neither be dumped nor restored so system should carefully inspect such types of files before restoring them from the dump taken.

### **13.8 File System Consistency :**

A file system is always dealing with blocks through Reading, modifying and writing blocks. Inconsistency may arise if a file system updates a block but the system is interrupted before the changes are written. This inconsistency becomes even worse when the unwritten block is free list, i-node or directory blocks. To overcome this problem, most systems implement a utility program to check for file system consistency that is run after each system boot like the scandisk for windows and fsck for UNIX. The consistency check can be performed on blocks or files. Two tables are constructed by the utility program during block consistency checking each table with counters for each block that is initialized with 0. The first table's counters count the number of times each block exist in that file while the second table's counters keep track of the number of times each block is found in the free list. List of all block numbers used in a file is constructed by the program from the i-node. The counter at the first table is then incremented for every block read. The program also checks the bitmap to see blocks not in use and increments the counter of the second table for every occurrence of a block in the bitmap. The consistency of the blocks will then be checked by checking the counters from the two tables.

If each block has a 1 value either in the first or second table, the program returns fine indicating block consistency while a value 0 in both tables corresponding to a block number indicates file inconsistency.

The utility program then fixes the inconsistency and informs the user. File consistency checking is also done in same fashion in a directory system. The inspection starts from the root directory and recursively descends through the tree. The file's usage counter is incremented for every file in each directory which will be checked against a list sorted by i-node numbers that indicates the number of directories where each file is found in. When a file is created, the counter starts at 1 and increments every time a file is linked. If the counters value match, the file is determined to be consistent. The inconsistency happens if the values of the counters do not match in which case the program should take measures to correct the values.

### **13.9 File System Performance :**

The time taken to access a disk is way longer than it takes to access main memory. But this disk access time can also be improved in several ways. As a result several file systems come with optimization techniques that would enhance the performance of disk access.

Caching is one method through which disk access time is optimized. Cache is a collection of storage blocks which are kept in memory but are logical part of a disk in order to enhance performance. Some systems maintain a separate section of main memory for a cache where blocks are kept under the assumption that they will be used again shortly. Other systems cache file data using a page cache. The page cache uses virtual memory techniques to cache file data as pages rather than as file system oriented blocks which is more efficient than caching through physical disk blocks, as accesses interface with virtual memory rather than the file system. All read requests first check the cache for the presence of the block in the cache. If the block is found, the demand will be replied without disk communication. On the other hand, if the block can't be found in the cache, the block will be fetched from the disk

on to the cache first and then the request is answered. Due to the large number of blocks found in cache, the system needs to respond quickly for a block's request. One way to do this can be through hashing the device and disk addresses and then look for the disk in the hash table. If a block is not found in the cache and needs to be brought and if the cache is already full, some blocks must be removed and re-written back to the disk and make some space for the new comer. This situation is similar with paging and thus the algorithms discussed for page replacement can also be used for block replacement as well.

Block read ahead is another technique used by file systems to optimize performance. This method brings blocks into the cache ahead before they are requested so that a hit rate is increased. With this method, a requested block and several subsequent blocks which are likely to be requested after current block is processed are read and cached. Retrieving these data from the disk in one transfer and caching them saves a considerable amount of time. This works well for sequentially accessed files where the file system checks if block a+1 exists in the cache while reading block and makes a schedule to read block a+1 to the cache.

However, if the file is randomly accessible, block read ahead has a disadvantage of tying up the disk bandwidth with writing unwanted blocks into the cache and even dropping possibly needed blocks from the cache.

Arranging blocks which more likely are accessed in sequence together also minimizes the amount of disk arm motion which in turn enhances disk access performance.

### **13.10 Check Your Progress :**

1. \_\_\_\_\_ file system is used by MS-DOS
2. \_\_\_\_\_ is found at sector 0 of a disk contains information used to boot an operating system from that disk.
3. The main disadvantage of \_\_\_\_\_ allocation method is the difficulty to obtain such contiguous locations especially when the file to be stored is large in size.
4. \_\_\_\_\_ allocation method stores each file as a linked list of disk blocks which may be stored at any particular disk address and using the first word of each block as a pointer to the next one
5. we need to have an efficient and optimal file system that can protect the information from \_\_\_\_\_ damages
6. \_\_\_\_\_ is one method through which disk access time is optimized

### **13.11 Let Us Sum Up :**

From a top level perspective, a file system is perceived as set of files, directories and operations defined to manipulate them which is quite different from its internal arrangements. File system implementers' or designers need to deal with storage allocation of files and also maintain the block file associations in order to place inline an efficient and reliable file manipulation schemes.

In this unit, we tried to discuss issues related with directory implementation File naming conventions, file searching efficiency, file sharing methods among users and applications, disk space management schemes, and disk quotas were

explored all of which are concern of system designers for the betterment of structured file arrangement.

A file has different organization when seen from the system's perspective. File system designers are thus required to focus on internal structures as storage allocation, disk space management, sharing of files, reliability and performance. Three methods are used to allocate space to file systems among which the i-node is known to be the optimal way. Directory-management routines must consider efficiency, performance, and reliability. A hash table is a commonly used method, as it is fast and efficient. Unfortunately, damage to the table or a system crash can result in inconsistency between the directory information and the disk's contents. A consistency checker can be used to repair the damage. Operating-system backup tools allow disk data to be copied to tape, enabling the user to recover from data or even disk loss due to hardware failure, operating system bug, or user error.

A file is a named collection of related information that are treated as a single entity defined by its creator and kept on secondary storage devices. File names can be of fixed length or variable length and are used to interact with it. A file can be structured in bytes, records or trees. Several user programs or system calls can be carried out to interact with files. Each device in a file system keeps a volume table of contents or a device directory listing the location of the files on the device. In addition, it is useful to create directories to allow files to be organized.

Three directory organization methods are available : a single-level, two-level and tree directory organization. A tree-structured directory allows a user to create subdirectories to organize files.

The file system resides permanently on secondary storage devices, mostly on disks which is designed to hold a large amount of data permanently. Physical disks may be segmented into partitions to control media use and to allow multiple, possibly varying, file systems on a single spindle. These file systems are mounted onto a layered logical file system architecture to make use of them. The lower levels deal with the physical properties of storage devices while the upper levels deal with symbolic file names and logical properties of files. The Intermediate levels map the logical file concepts into physical device properties. Disk space is allocated to files through three different mechanisms. Directory-management routines must consider efficiency, performance, and reliability of file systems.

**13.12 Check Your Progress : Possible Answers :**

- |               |                             |
|---------------|-----------------------------|
| 1. FAT        | 2. Master Boot Record (MBR) |
| 3. Contiguous | 4. Linked                   |
| 5. Logical    | 6. Caching                  |

**13.13 Assignment :**

- Discuss about the MBR along with its contents.
- What are the file sharing schemes used by a file management system ?
- What advantages and disadvantages do you observe on disk quota specification ?

## **Operating System and Software Installation**

- What is a free block space management ? Why is it necessary for the system to identify free blocks ? What schemes are used by the system to manage these free blocks ?
- What are the mechanisms used by a file system to check for consistency ?

### **13.14 Activity :**

- Discuss in pair cons and pros of the three file storage allocation methods on hard disks
- Discuss about bitmap and linked list free space management implementations.

### **13.15 Case Study :**

- Identify the problems with contiguous file allocation

### **13.16 Further Reading :**

- Tanenbaum, Modern Operating System, second edition, 2001
- William Stalling, Operating Systems : Internals and Design Principles, seventh edition, 2011

**BLOCK SUMMARY :**

- One of the fundamental and complex tasks of an operating system is memory management.
- Memory management involves treating main memory as a resource to be allocated to and shared among a number of active processes.
- To use the processor and the I/O facilities efficiently, it is desirable to maintain as many processes in main memory as possible.
- It is desirable to free programmers from size restrictions in program development.
- The basic tools of memory management are paging and segmentation.
- With paging, each process is divided into relatively small, fixed-size pages.
- Segmentation provides for the use of pieces of varying size. It is also possible to combine segmentation and paging in a single memory management scheme.
- To use the processor and the I/O facilities efficiently, it is desirable to maintain as many processes in main memory as possible.
- With virtual memory, all address references are logical references that are translated at run time to real addresses.
- A virtual memory management scheme requires both hardware and software support. The hardware support is provided by the processor. The support includes dynamic translation of virtual addresses to physical addresses and the generation
- I/O devices are interfaces that communicate users with the computer system. To manage the communication effectively, the operating system uses the I/O subsystem, which has a complete layer of hardware and software.
- The aspect of I/O that has the greatest impact on overall system performance is disk I/O. Two of the most widely used approaches to improve disk I/O performance are disk scheduling and the disk cache.
- Disk scheduling minimizes the mechanical seek time of the disk and hence improves performance.
- A disk cache is a buffer, usually kept in main memory that functions as a cache of disk blocks between disk memory and the rest of main memory.
- Because of the principle of locality, the use of a disk cache should substantially reduce the number of block I/O transfers between main memory and disk.
- A file is a named collection of related information defined by its creator.
- File is an abstraction used by the kernel to represent and organize the system's non-volatile storage resources, including hard disks, CD-ROMs, and optical disks.
- File system is part of the operating system that manages files.
- A file can represent a program or data and can support free form or rigid form.



## **Operating System and Software Installation**

- A file can be structured in byte, record or tree form and can be accessed either sequentially or randomly.
- The operating system uses several types of operations, through system calls, to interact with files.
- Each device in a file system keeps a volume table of contents or a device directory listing the location of the files on the device. In addition, it is useful to create directories to allow files to be organized.
- Three directory organization methods are available : a single-level, two-level and tree directory organization. A tree-structured directory allows a user to create subdirectories to organize files.
- Disk space is allocated to files through three different mechanisms. Directory-management routines must consider efficiency, performance, and reliability of file systems.

### **BLOCK ASSIGNMENT :**

#### **Short Questions**

- What is paging ?
- What is segmentation ?
- What is virtual memory ?
- What is page fault ?
- When does internal fragmentation occurs ?
- What is file ?
- What is a directory ?
- What is a path ?
- What is backup ?
- How can a disk access time be enhanced ?
- What are the three space allocation methods used in file systems ?
- What is the difference between file and block ?
- What are the two file access methods ?
- Do we need a rewind operation in a random access files ?
- What are the open() and close() operations used for ?
- What is caching ?

#### **Long Question**

- Discuss the methods of backup
- What are the main issues need to be addressed in disk space management in relation to file systems ?
- Explain the difference between single versus multiple partition allocation.
- Explain advantages of FAT linked list file allocation
- What are the problems with contiguous file allocation ?
- What are the merits and demerits of the two file sharing methods ?



Dr. Babasaheb Ambedkar  
Open University Ahmedabad

BCAR-102/  
DCAR-102

## **Operating System and Software Installation**

---

### **BLOCK 4 : PROTECTION, SECURITY AND SOFTWARE INSTALLATION**

---

UNIT 14 SECURITY

UNIT 15 PROTECTION

UNIT 16 OPERATING SYSTEM AND APPLICATION SOFTWARE  
INSTALLATION

# ***PROTECTION, SECURITY AND SOFTWARE INSTALLATION***

## **Block Introduction :**

This block introduce security with key terms, System security objectives, system security attacks It also discuss the design principles of an Operating System, Cryptography, User Authentication methods and Access Control. It also explains how to install windows operating system and microsoft office package on your computer.

## **Block Objectives :**

The objective of this block is to explain what a computer security entails and different threats to a system security. to discuss the goals and principles of protection in a modern computer system and different security protection mechanisms enforced by a system. To familiarize learners with upgrade and clean installation of Windows 10 operating system and how to download, install and activate Microsoft Office 365 on personnel computer.

## **Block Structure :**

**Unit 14 : Security**

**Unit 15 : Protection**

**Unit 16 : Operating System and Application Software Installation**

# *FILE SYSTEM IMPLEMENTATION*

## **UNIT STRUCTURE**

- 14.0 Learning Objectives
- 14.1 Introduction
- 14.2 Key Terms
- 14.3 System Security Objectives
- 14.4 System Security Attacks
- 14.5 Check Your Progress
- 14.6 Let Us Sum Up
- 14.7 Check Your Progress : Possible Answers
- 14.8 Assignment
- 14.9 Activity
- 14.10 Case Study
- 14.11 Further Reading

### **14.0 Learning Objectives :**

Upon completion of this unit you should be able to :

- Explain what a computer security entails
- Identify different threats to a system security

### **14.1 Introduction :**

Operating system consists of a collection of objects, hardware or software each object with unique name that can be accessed through a well-defined set of operations. The system should allow different users to access different resources in a shared way and needs to ensure that each object is accessed correctly and only by those processes that are allowed to do so. Security ensures the authentication of system users to protect the integrity of the information stored in the system as well as the physical resources of the computer system. The security system prevents unauthorized access, malicious destruction or alteration of data, and accidental introduction of inconsistency. Protection mechanisms control access to a system by limiting the types of file access permitted to users. In addition, protection must ensure that only processes that have gained proper authorization from the operating system can operate on memory segments, the CPU, and other resources. This unit covers in detail the concept of operating system security and the mechanisms used to provide system protection. We start our discussion with different security threats, intruders, and accidental data losses followed by the protection mechanisms enforced to overcome the threats.

<b>14.2 Key Terms :</b>	
Computer Security	The prevention and protection of computer resources from unauthorized access, use, alteration, degradation, destruction, or any other problem.
Threat	Any person, act, or object that poses a danger to computer security
Intruder	Any person, or program that carries out malicious or unauthorized activity on a system and jeopardize its safety.
Attack	A threat that is carried out or practiced on a system
Cryptography	A means used to hide communicated message content
Authentication	is a process of validating one's identity
Access Control	A method used to define users' interaction with a system

"The most secure computers are those not connected to the Internet and shielded from any interference". However, in this era of information access anywhere and at anytime, the phrase violates the goal of communication and resource sharing.

- How can one then keep itself connected and accessible anytime without jeopardizing its safety ?
- What are the concerns out there that threatens one's safety ?
- What measures one shall take to overcome these threats ?

This unit builds your knowledge about computer security concerns as well as counter measures set by the operating system to be taken to secure all resources of a system.

Current computer systems are designed in a way to handle several resources and bulk information. As the number of information stored grows, the need to protect this information from damage, unwelcomed change as well as unintended access is becoming more important. However, several sophisticated systems are also being used that opposes the objectives of the operating system and abuse the information causing catastrophic disasters. Security refers to the wellbeing of a system that requires adequate protection as well as consideration of the external environment within which the system operates. A secured system is thus, a system whose resources are used as intended in all situations. There are several situations which violates security and causes a system unsecured.

These problems can be external or internal to the system as well as intended or unintended problems. Computer Security aims in safeguarding a system from external threats as well as from legitimate users as possible attackers.

<b>14.3 System Security Objectives :</b>
--

System security has three main objectives. These are :

- **Confidentiality** : preventing, detecting and deterring improper disclosure of information.
- **Integrity** : preventing, detecting and deterring improper modification of information

- **Availability** : preventing, detecting and deterring improper denial of access to services. Security has many aspects among which the behavior of the threat, the attacker and inadvertent data loss are the most important ones which will be discussed in detail in this unit.

1. **Threats** : A threat is a potential occurrence of an event which results in unpleasant effect on the data and resources of a computer system. These are basically situations which attacks the three goals of a system security Confidentiality is basically about secrecy of information which requires an information should not be exposed to unauthorized users. Integrity focuses on protecting information from alteration and deletion by unauthorized users. Availability deals with avoiding disturbances that cause a system to be unavailable or unusable. Exposure of information, altering information, and denial of service are the threats faced by the security objectives mentioned respectively. The disclosure threat exposes an asset to someone who is illegitimate to have that. This may happen while the resource is still maintained in the computer or during communication over a communication channel. An integrity attack alters data found on a computer system or in transit over the network. Denial of service threat deprives legitimate users from getting access to computer system resources.

2. **Intruders** : Intruders are people or malicious programs breaching security. These are people causing security threats usually by trying to gain access to a system, or to increased privileges to which they are not entitled, often by obtaining the password for a legitimate account or programs written by highly skilled programmers for unhealthy intentions of penetrating a system and exploiting its resources illegitimately. Intruders can act in two different ways. An active intruder tries to make unintended changes to data and is more dangerous. A passive intruder listens or eavesdrops a data that is not allowed to it. Intruders use several standard methods in their attempts to breach security each requiring different protection means.

- **Casual prying by naive users** : these are people with no technical knowledge but read other users information
- **Snooping** : highly experienced users trying to break the security of a system to test their capability.
- **Making money** : determined attempts to change mostly financial data and get money as a result.
- **Commercial espionage** : spying information for a particular content without the knowledge of the owner

The malicious program considered as intruder is known as a virus. Virus is a snippet of code capable of replicating itself by attaching itself to normal programs in the system and damage the system. The damage caused by a virus is general in that it attacks all resources of a system.

3. **Accidental data loss** : There are also several situations causing unintentional important data losses in a system which results more damage than intruders. Some of the causes resulting accidental data loss are :

- **Natural phenomenon** : accidents like earthquake, fire, flood, etc
- **Hardware or software error** : malfunctioning of CPU, disk failures, errors in programs
- **User errors** : invalid input, wrong program run, disk loss, wrong disk mount, etc

These problems can be solved mostly by taking appropriate and adequate backups on devices furthest away from the original location

#### **14.4 System Security Attacks :**

In this topic, we will try to explore the different attacks exercised on a system security along with design principles to be considered while developing an operating system so that a system can have a resistance to these attacks.

A system can be attacked by different attacking situations that test its vulnerability. The attacks can be physical which involves stealing or physically damaging system's resources or logical which involves using malicious programs and damage system's resources. In general computer security attacks are classified as inside or outside attacks.

##### **Inside attacks :**

These kind of attacks are carried out by an entity which has an access privilege. The attacker can steal or physically damage resources or after successful penetration to a system, the intruder can perform its desired operation and attack the system. Several inside logical attacks can be imposed on systems. To mention some :

**Trojan horses** : is an apparently innocent program but with codes inside that causes unintended operation such as modifying, deleting or even transferring the user's information onto the attacker's location. These programs trick the user by using an appealing and convincing presentation which makes the user believe and run the program.

**Login spoofing** : the attacker presents a fake login interface which looks exactly like the true login interface. The user then gives his/her authentication data to the fake interface which collects and sends the information to the attacker and exits. The original login interface is displayed then and the user believes of making some error previously on the information and thinks the system is displaying the interface for the second time.

**Logic bomb** : is a code embedded in a program that "explodes" when certain conditions are met, e.g. a certain date or the presence of certain files or users. Logic bombs also often originate with the developers of the software.

**Trap doors** : is a secret entry point into a program, often left by the program's developers, or sometimes delivered via a software update. These are codes included into a program to help the attacker bypass some normal checks.

**Buffer overflow** : is an attack that happens on a system by exploiting bugs in a program and using these bugs to damage the system. The bug can be a simple case of poor programming, in which the programmer neglected to code bound checking on an input field. The attacker after examining the nature and holes of the program, writes a program that sends more data than the program was expecting causing memory overwriting by those outbound values.

**Outside attacks :**

These are attacks caused by an attacker from outside the system mostly on a network. These attacks make use of codes being transmitted to the targeted machine over a network and runs on it causing the damage. These codes are known as malicious codes and can be virus, worm, mobile codes or java applets.

**Virus :** is a program that replicates by attaching itself with another program and causing harm on the system's resources. The attacker distributes the virus by attaching it to an appealing program which is more likely to be used by users (games, free apps, etc). After penetrating the system, the virus remains inactive until the victim application is launched and when initiated, it starts affecting other programs in the system. Viruses are of different types according to their properties and activation methods.

Preventing a virus from penetrating into a system on the first place is an ideal solution to protect a system from a virus attack which is very difficult, if not impossible, to do in the era of networked systems. So the best alternative towards virus protection could be detection of a virus, once detected identifying its type, and then trying to remove it from the system or if not possible remove the entire affected program. These are carried out by special programs known as antivirus. Antivirus programs are used to protect system from being affected by viruses. An antivirus maintains definition for viruses which is the pure code of the viruses. The antivirus then inspects executable files of the system to check if there is a code matching the virus definition. If so, they try to fix the program by removing the virus code.

**Worm :** is similar with virus except it has self-replicating capability and does not need to attach itself on other programs to duplicate itself. It is an independent program that spreads via network connections, typically using either email, remote execution, or remote login to deliver or execute a copy of itself to or on another system, as well as causing local damage.

**14.5 Check Your Progress :**

1. \_\_\_\_\_ is the prevention and protection of computer resources from unauthorized access, use, alteration, degradation, destruction, or any other problem.
2. \_\_\_\_\_ is a method used to define users' interaction with a system
3. System security has \_\_\_\_\_ main objectives
4. \_\_\_\_\_ is preventing, detecting and deterring improper modification of information
5. \_\_\_\_\_ is preventing, detecting and deterring improper denial of access to services
6. \_\_\_\_\_ is a potential occurrence of an event which results in unpleasant effect on the data and resources of a computer system.
7. \_\_\_\_\_ are people or malicious programs breaching security.
8. \_\_\_\_\_ attacks are carried out by an entity which has an access privilege
9. \_\_\_\_\_ attacks make use of codes being transmitted to the targeted machine over a network and runs on it causing the damage
10. \_\_\_\_\_ is similar with virus except it has self-replicating capability and does not need to attach itself on other programs to duplicate itself.



#### **14.6 Let Us Sum Up :**

Security in a computer system focuses on safeguarding the resources (hardware, software) of a system. Several conditions threaten the proper functioning of a system through exploitations of the possibilities for attacking the system. A system's resource may be damaged by intention or non-intentionally. Intruders are people and programs that intentionally damage a system while accidental data loss is non-intended system damage as a result of different phenomenon like natural accidents, hardware/software errors etc...

An attacker is always in an attempt to damage a system. System attacks can be either internal which happens after a user successfully logs in or external from a distant place especially in networked systems. Trojan horse, logic bomb, spoofing, buffer overflow are some of the attacks from inside the system while viruses, worms, mobile codes are attacks from outside the system.

#### **14.7 Check Your Progress : Possible Answers :**

1. Security
2. Access Control
3. Three
4. Integrity
5. Availability
6. Threat
7. Intruders
8. Inside
9. Outside
10. worm

#### **14.8 Assignments :**

1. What is a threat ?
2. What differences are there between active and passive intruder ?
3. What makes intruders attack a system ?
4. What are the three goals of computer security ?

#### **14.9 Activity :**

- Install any anti-virus program on your computer / laptop

#### **14.10 Case Study :**

- Study security features of windows operating system

#### **14.11 Further Reading :**

- Andrew S. Tanenbaum (2008). Modern Operating System. 3rd Edition. Prentice-Hall.
- Optional readings and other resources for Encryption, User Authentication, and types of attacks :
- William Stallings (2005). Cryptography and Network Security
- Principles and Practices, 4th edition. Prentice Hall
- A Silberschatz, Peter B Galvin, G Gagne (2009). Operating
- System Concepts. 8th Edition. Wiley.

**UNIT STRUCTURE**

- 15.0 Learning Objectives
- 15.1 Introduction
- 15.2 Design Principles of an Operating System
- 15.3 Cryptography
- 15.4 User Authentication
- 15.5 Access Control
- 15.6 Check Your Progress
- 15.7 Let Us Sum Up
- 15.8 Check Your Progress : Possible Answers
- 15.9 Assignment
- 15.10 Activity
- 15.11 Case Study
- 15.12 Further Reading

**15.0 Learning Objectives :**

Upon completion of this unit you should be able to :

- Discuss the goals and principles of protection in a modern computer system
- Discuss the different security protection mechanisms enforced by a system

**15.1 Introduction :**

An operating system has the responsibility of enforcing security protection mechanisms to avoid possible threats from happening and protect the various objects of a system. Each asset of a system has a name and well defined set of operations through which access is made. In this section various countermeasures set by a computer system to protect itself against security attacks will be addressed along with the design principles that shall be followed to strengthen system's security.

**15.2 Design Principles of an Operating System :**

A core set of principles to operating system security design are :

**Least privilege :** Every object (users and their processes) should work within a minimal set of privileges; access rights should be obtained by explicit request, and the default level of access should be "none".

**Economy of mechanisms :** security mechanisms should be as small and simple as possible, aiding in their verification. This implies that they should be integral to an operating system's design, and not an afterthought.

**Acceptability :** security mechanisms must at the same time be robust yet non-intrusive. An intrusive mechanism is likely to be counter-productive and avoided by users, if possible.

**Complete** : Mechanisms must be pervasive and access control checked during all operations including the tasks of backup and maintenance.

**Open design** : An operating system's security should not remain secret, nor be provided by stealth. Open mechanisms are subject to scrutiny, review, and continued refinement.

With this in mind, let's move our discussion to some major security guarding mechanisms implemented by a system to assure secured resource communication and access

### **15.3 Cryptography :**

Have you ever heard the word cryptography ? Or have you seen people communicating with some weird, non-understandable writings where only the communicating parties know what it means ? Well, in this activity we are going to address what a cryptography is, which is one of the most popular security provision ways, its importance in a system security and discuss some cryptography schemes .Encryption is a process of transforming a message with an intention of hiding its meaning to avoid possible attacks on it. Encryption is achieved with a concept of cryptography which converts the original data, termed as plaintext, into a secreted one, termed as cyphertext that can only be understood and reverted back by legitimate users of the data. Reverting back from the cyphertext to the plaintext is known as decryption.

Most of the time encryption and decryption works well through security by obscurity where the encryption and decryption algorithms are made publicly accessible while the contents are private.

Encryption and decryption algorithms have a secret parameter known as key which needs to be known by only authorized users and with which the text is converted to its required representation (cypher for encryption and plain for decryption). An encryption function can be stated as  $C = E(P, K_e)$  where a cyphertext C is obtained by an encryption algorithm E implemented on a plaintext P with an encryption key  $K_e$ .

The decryption can also be stated as  $P = D(C, K_d)$ , where a plaintext P of an encrypted data is obtained by implementing a general decryption algorithm D with the cyphertext C and decryption key  $K_d$  as parameters.

Figure 1 shows the pictorial representations for encryption and decryption



**Fig. 1 : Encryption and Decryption of a Message**

Properties of good encryption technique are :

- a. Relatively simple for authorized users to encrypt and decrypt data.
- b. Encryption scheme depends not on the secrecy of the algorithm but on a parameter of the algorithm called the encryption key.
- c. Extremely difficult for an intruder to determine the encryption key.

There are two methods of cryptography : Secret key cryptography and public key cryptography.

**Secret key cryptography** is also known as symmetric cryptography which uses same key for encryption and decryption. It also requires on establishing a secured channel to communicate the symmetric key used for both encryption and decryption among the communicating bodies. Three types of algorithms are known to use secret key cryptography : substitution where each letter in the plain text is replaced with another letter to get the cyphered text, transposition where the positions of the characters in the plaintext are transposed to some specified position, and data encryption system (DES) which is combination of the two. The main advantage of this cryptography is its efficiency in computing the cypher as well as plain text but has a disadvantage of requiring secret key communication which is very difficult especially when the communicating parties are apart.

**Public key cryptography** also known as asymmetric key cryptography is a method used to overcome the limitation of the symmetric key cryptography by using mathematical functions. It uses two different keys for encryption and decryption, one secret and the other public to encrypt and decrypt a message. The encryption key is mostly made public while the decryption key is private, though it depends on the purpose of the cryptography usage. The public key cryptography works by first generating a pair of related keys, private key and public key, and publicizing the public key of all communicating entities. The sender party then encrypts the message using that public key of the receiver while the receiver decrypts it with the associated secret decryption key it only has. RSA is the most widely known public key cryptography.

#### 15.4 User Authentication :

Another security ensuring mechanism used by a computer system is user authentication. This resembles a real world situation where you are asked to bring out your student identification paper to be allowed, for instance, to get into the university compound. Unless and otherwise you come with valid and not outdated student identification paper, you will not be allowed to enter into the compound. A computer system also make use of such kind of scheme to filter between legitimate and non-legitimate users based on which resources are granted or denied. Let's define what user authentication is and the various schemes used to carry out user authentications by a system along with their merits and demerits.

Mostly an operating system allows users to use system's resource based on their identity which is based on authentication. User authentication is a processes of determining the identity of a user based on which his/her permitted activities are also identified. It allows an entity (a user or a system) to prove its identity to another entity. Typically, the entity whose identity is verified reveals knowledge of some secret S to the verifier. The computer system performs authentication when a user attempts to log into a system and is based on four different principles. These are :

- Based on what the user knows : including Password, personal information, PIN, Secret Question
- Based on what the user is : also referred as biometrics which includes Fingerprints, voiceprint, signature dynamics

## **Operating System and Software Installation**

- Based on what the user has : Physical key, ticket, passport, token, smart card
- Based on something about the user's context : including Location, time
- Each of these principles set their own authentication requirement with different security properties and different level of complexity. Let's see each of the principles separately.
- Authentication with what the user knows (password)

This is probably the oldest authentication mechanism which is also most widely used by computer systems. This method requires the user to type username and password on login. For each user, system stores (ID, F(password)), where F is some transformation (e.g., one-way hash) in a password file. When user enters the password, system computes F(password) to check if a match can be found to proof the identity. It is needless to say that a password should not be visible when typed but different systems use different techniques towards this. For example windows operating system displays boxes in place of each character in a password while LINUX displays nothing at all when the user types the password. Passwords have an advantage in their ease to modify when compromised but comes also with several vulnerabilities to attack. Inherent vulnerabilities are : easy to guess or snoop and no control on sharing. Practical vulnerabilities are visible if unencrypted in distributed and network environment, and susceptible for replay attacks if encrypted naively. Due to these vulnerabilities, an intruder can attempt to attack one's password. The possible attacks on password are :

### **Guessing attack/dictionary attack**

This is a trial and error attack which exploits human nature to use easy to remember passwords. An intruder needs to know the user or have some information about the user to perform a guessing attack. Alternatively, the attacker can do Brute-force attack by trying all possible passwords using exhaustive search until it matches. Mostly, passwords of shorter length are susceptible to this brute force attack as it is possible to get the password after a limited number of guessing attempts.

But it becomes less successful on systems that allow longer passwords that include both uppercase and lowercase letters, numbers and all punctuation characters

### **Social Engineering**

Attacker asks for password by masquerading as somebody else (not necessarily an authenticated user)

### **Sniffing**

Anyone with access to a network on which a computer resides can seamlessly add a network monitor, allowing him/her to watch all data being transferred on the network including user IDs and passwords. Encrypting the data stream containing the password solves this problem. Even such a system could have passwords stolen, however.

### **Trojan login**

Trojan horses are seemingly normal programs but with hidden activities of accessing system's resources by making the user believe it is safe. Trojan

login is thus, tricking someone into executing a program that does nasty things. This Trojan program installed on the system captures every keystroke before sending it on to the application.

### **Improving password security**

Different techniques can be used to enhance the security of a password by eliminating the security threats and reducing its vulnerability. Some of the techniques used are :

- Educate users to make better choices. Better passwords can be constructed by combining letters (upper and lower), digits and symbols and making them lengthy, using non-guessable phrases, etc.
- Define rules for good password selection and ask users to follow them
- Ask or force users to change their password periodically such as one time password which forces users to change their password after each login.
- Actively attempt to break user's passwords and force users to change broken ones.
- Screen password choices. Some systems use a password screening module that forbids users from using a vulnerable password.

Challenge–response authentication can be combined with password authentication where the user provides list of questions with answers at password creation and the system picks any of the questions randomly and asks the user during every login attempt to make sure the password is used by the owner. The problem with this method is, however, several question–answer pair might be required. Challenge–response is a variant of this method which lets the user pick an algorithm during registration. The system then gives an argument for the user on an attempt to login where the user returns the computed result of the argument by applying the algorithm picked during registration.

The challenge response authentication method, in general, asks the user questions no one else would know the answer to except the user.

### **Authentication with what the user is (biometrics)**

This authentication method uses physical properties of a user known as biometrics. These physical properties include Fingerprint, Retina scan, Voice pattern, Signature, Typing style. A biometric system is constructed from enrollment and identification part. The enrollment part measures and collects the physical property and associates it with a user defined username. The identification part starts its work when the user attempts to login. It requests the user to provide his/her username and makes the physical property measurement again which will be checked against the previously collected value by the enrollment. If they match, the system allows the user to get access.

Biometrics have been hailed as a way to get rid of the problems with password and token–based authentication though, they have their own problems mostly cost and rare false readings. The physical property considered should be picked in such a way that clear distinguishing can be made between two people and also is durable characteristics that does not change much over time. For instance using a hair color as a physical characteristic would not be appropriate as more than one person can have same color. Moreover, voices,

face figures and the like that varies greatly based on current situations, are also not good candidates to be measured and recorded for a physical property of a person.

**Authentication with what the user has**

This is an authentication method that uses a physical object possessed by a user such as ATM cards, smartcards, etc... inserted into a reader machine which is capable of reading the content associated with the object from the central database kept with the object provider. This method uses a personal identification number (PIN) or even a biometrics data associated with each object owned by a user to authenticate the user. Smart cards are the most commonly used physical objects recently. Smart cards are portable devices with a CPU, I/O ports, and some nonvolatile memory.

**Authentication with the user's context**

This is also referred as next generation's authentication method. It works by analyzing various user's attributes such as logon attributes based on a set of configurable parameters including geographical location, IP address, time of day, and device recognition and generates a context assurance level. These context assurance level requires a different level of authentication as administrators optimize security for any given logon instance. Context based authentication allows the system to create rules that determine, pre-authentication, whether and how a given authentication process should proceed based on context.

**15.5 Access Control :**

System needs to make sure that assets are accessed correctly only by those processes that are allowed to do so. Associated with each user, there can be a profile that specifies permissible operations and accesses and through the user access control procedure (log on), a user can be identified to the system. The operating system can then enforce rules based on the user profile.

Access control is a process of verifying access rights to prevent misuse of resources. Three types of access control models can be used to ensure the right objects are accessed only by the right processes. These are : Discretionary Access model, Mandatory Access model and Role-Based Access model

**Discretionary Access Model, DAC**

Access control is based on User's identity and Access control rules. DAC has policies that manage subject to object interaction based on identifications of subjects, objects as well as allowed operations assigned for each subject on each object. When a subject shows an interest to communicate with an object, DAC grants the request by first verifying whether the subject has such a right or not on that object.. To do so, DAC uses a matrix of access rights for each subject on each object. Cells of the matrix contain an expression that represents the rights as shown in figure 2 below

## Access Control Matrix

User	File1	File2	File3
Diane	Read and execute	Read, write and execute	No access
Katie	Read and execute	Read	No access
Chrissy	Read, write and execute	Read and execute	Read
John	Read and execute	No access	Read and execute

- **Access Control Lists (ACLs)**
  - Specifies the list of subjects that are authorized to access a specific object
- **Capability Lists**
  - Specifies the access rights a certain subject possesses pertaining to specific objects

**Fig. 2 : 2 Matrix Representation for Access Control**

This matrix can be implemented in two different ways.

Access Control List (ACL) : lists users with their access rights to objects. It Stores the access matrix by columns. With each object  $O_j$ , a list of pairs  $\langle S_i, A[S_i, O_j] \rangle$  is stored for each subject  $S_i$ , such that  $A[S_i, O_j]$  is not null. DAC consults ACL every time the user submits an access request. Figure.3 depicts an ACL organization.

<b>Access Control List for Program1:</b> Process1 (Read, Execute)
<b>Access Control List for SegmentA:</b> Process1 (Read, Write)
<b>Access Control List for SegmentB:</b> Process2 (Read)

**Fig. 3 : ACL for Processes**

The advantage of ACL is that it is simplicity to be sustained as it only requires removing of a row when an object is deleted and query the system on an object basis is also easy. However identifying all objects a subject can communicate with is difficult on top of the difficult subject based grant and revoke operations.

Capability List, CL

<b>Capability List for Process1:</b> Program1 (Read, Execute) SegmentA (Read, Write)
<b>Capability List for Process2:</b> SegmentB (Read)

**Fig. 4 : Depicts CL Implementation of an Access Control**



Each user is given a number of capability tickets specifying authorized objects and operations for a user. This implementation stores the access matrix by rows where each subject  $S_i$  is the label of the access matrix rows. a list of pairs  $\langle O_j, A[S_i, O_j] \rangle$  is associated for each object  $O_j$ , such that  $A[S_i, O_j]$  is not empty. Each row of the CL stores objects and the access rights granted to the subject on the objects. CL is also advantageous due to the easy maintenance and simple query system which is subject based. However, the computational difficulty of identifying the set of subjects that have access right on a given object exists here as well. Moreover, revoking access rights of subjects for removed objects and granting rights to a newly created objects is time taking.

**Mandatory Access Control model, MAC**

Regulates the flow of information by assuring information goes only to the intended recipients. When a system mechanism controls access to an object and an individual user cannot alter that access, the control is a mandatory access control (MAC). This model is important for environments requiring a much tighter security such as military system. Once access is defined, altering is not possible by users. The Bell-La-Padula model and the Bela model are access control models based on MAC.

**Role-Based Access Control model, RBAC**

Access rights are defined based on the role(s) a user has instead of his/her identity (DAC) or his/her clearance (MAC). Access rights are defined based on subject roles. It is used to express organizational policies with delegation of authority and separation of duties.

**15.6 Check Your Progress :**

❖ **Matching :**

A		B	
1	Cipher	a	Access can't be altered by users, once defined
2	Fingerprint	b	Assets can only be modified by authorized users
3	Substitution	c	Coded message
4	Logic Bomb	d	Authentication method
5	MAC	e	Letters of plain text replaced by other letters
6	Integrity	f	Code embedded in a program certain and explodes when conditions are made

**15.7 Let Us Sum Up :**

A computer system needs to protect itself from unwanted and illegitimate access. To do so, it sets various system protection mechanisms among which cryptography, user authentication and access control are the major ones.

A computer system has different resources that it needs to control to avoid misuse of these resources. As the communication scheme has changed to a networked communication where one system interacts with other several systems, possibilities of resource misuse is growing which needs more jobs to be done to secure a system. A threat is a potential situation that results

in unsecured system. Three general security threats are there violating the objectives of system security. The threats are initiated by intruders which can be either active or passive and attack a system through different attacking mechanisms. Attacks happen from inside a system or outside a system and can be intentional or non-intentional. System uses different mechanisms to protect itself from such attacks including cryptography, user authentications, access control mechanisms, other software methods like use of anti-viruses, etc.

Cryptography, one security enforcement mechanism, is a science and art of communication where by the communicated information is changed to a code that can't be perceived by any other entity except the communicating ones. It encompasses both encryption and decryption schemes to achieve its objective.

Encryption is a way used to hide information communicated between a sender and a receiver with an objective of avoiding any harm on the information by illegitimate users. A message encrypted on the sender side needs to be reverted back to its original representation with a process of decryption.

Cryptography can be symmetric or Asymmetric depending on the code generation method it utilizes.

Authentication is another important aspect of a system used to assure security of resources. It is a means by which object's identity is validated for further service provision. The system uses several methods of authentication such as authentication by password, question-response, biometrics, physical objects, etc. The third major security provision method is an access control mechanism through which every object of a system is associated with each subject including people in terms of allowable operations. Access control is thus a way of managing permissions to subjects on objects. Three access control model are DAC, MAC, and RBAC each with their own implementation.

### **15.8 Check Your Progress : Possible Answers :**

- |         |         |         |
|---------|---------|---------|
| 1. (c), | 2. (d), | 3. (e), |
| 4. (f), | 5. (a), | 6. (b)  |

### **15.9 Assignment :**

- How does the public key cryptography overcome the limitations of private key cryptography ?
- How does a receiver convert a cyphertext to a plain text in a substitution private key cryptography ?
- What are the possible vulnerabilities of a password ?

### **15.10 Activity :**

- Implement one of the private key cryptography algorithms using your preferred programming language
- Implement the RSA cryptography algorithm using your preferred programming language

### **15.11 Case Study :**

- Windows operating system protection mechanisms

**15.12 Further Reading :**

1. Andrew S. Tanenbaum (2008). Modern Operating System. 3rd Edition. Prentice–Hall.
2. Optional readings and other resources for Encryption, User Authentication, and types of attacks :
3. William Stallings (2005). Cryptography and Network Security
4. Principles and Practices, 4th edition. Prentice Hall
5. A Silberschatz, Peter B Galvin, G Gagne (2009). Operating
6. System Concepts. 8th Edition. Wiley.

**Unit**  
**16**

***OPERATING SYSTEM AND  
APPLICATION SOFTWARE  
INSTALLATION***

**UNIT STRUCTURE**

- 16.0 Learning Objectives
- 16.1 Introduction
- 16.2 Windows 10 Upgrade Installation
- 16.3 Windows 10 Clean installation
- 16.4 Windows 10 Out-Of-Box Experience
- 16.5 Install Microsoft 365 or Office 2019 on a PC
- 16.6 Check Your Progress
- 16.7 Let Us Sum Up
- 16.8 Check Your Progress : Possible Answers
- 16.9 Assignment
- 16.10 Activity
- 16.11 Case Study
- 16.12 Further Reading

**16.0 Learning Objectives :**

Upon completion of this unit you should be able to :

- Install or update windows 10 Operating system\
- Configure Windows 10 using Windows 10 out-of-box experience (OOBE)
- Install microsoft office 2019

**16.1 Introduction :**

There are two approaches you can take for installing Windows 10 in your computer :

Upgrade or a Clean Install. Typically, when you upgrade your operating system, all your documents and applications remain unchanged, whereas with a clean install you would be starting again from scratch. But one important thing to verify first is if your computer has the necessary hardware to support Windows 10.

**16.2 Windows 10 Upgrade Installation :**

Although most computers nowadays probably have the necessary requirements for

Windows 10. It will certainly be useful to know them in case you want to upgrade from an older system. The main requirements are :

- A processor (CPU) with a clock rate of at least 1GHz.
- At least 1 to 2GB of memory (RAM), but Microsoft recommends 4GB.

## Operating System and Software Installation

- At least 16GB space in your hard disk.
- One important thing to note is that the installation process itself will verify your computer hardware and let you know if it qualifies for a Windows 10 upgrade or not. If not, then you will need to upgrade your hardware.

If your computer qualifies for a Windows 10 upgrade, then you can follow these steps to perform the upgrade :

**Step 1 :** Look for the Windows 10 notification in the lower-right corner of the screen.

This is a one-year-only offer that Microsoft is extending to valid users of Windows 7 and Windows 8.1.



**Step 2 :** By clicking on the notification, it will start the download and installation process of Windows 10 in your system.

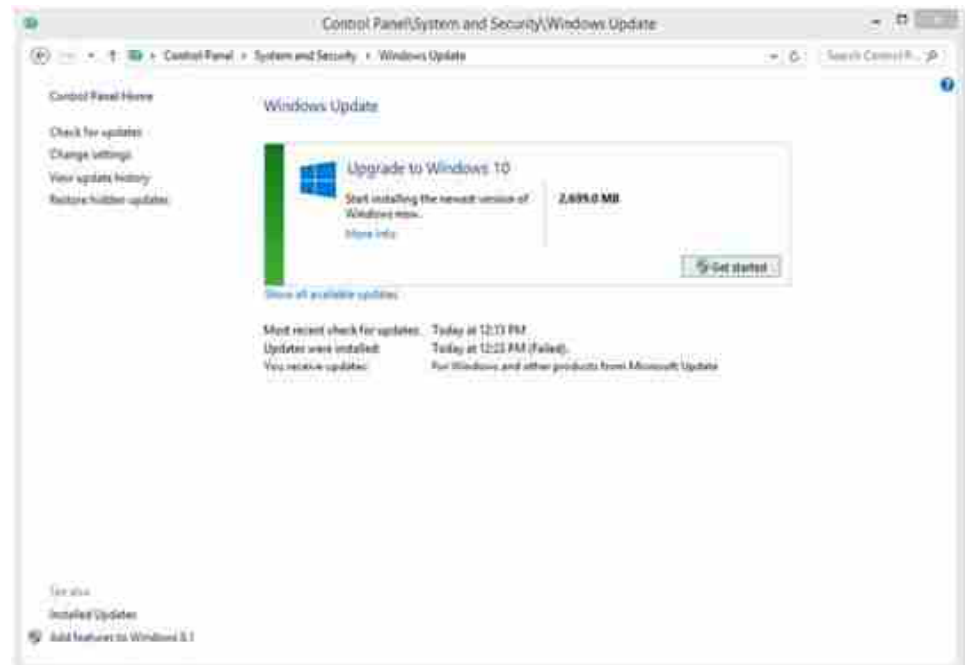

The download required for the upgrade is quite large, so make sure you have a stable Internet connection and continuous power for your computer to avoid interruptions during the process.

**Step 3 :** After the download is complete, it will prompt you to accept Microsoft's license terms.

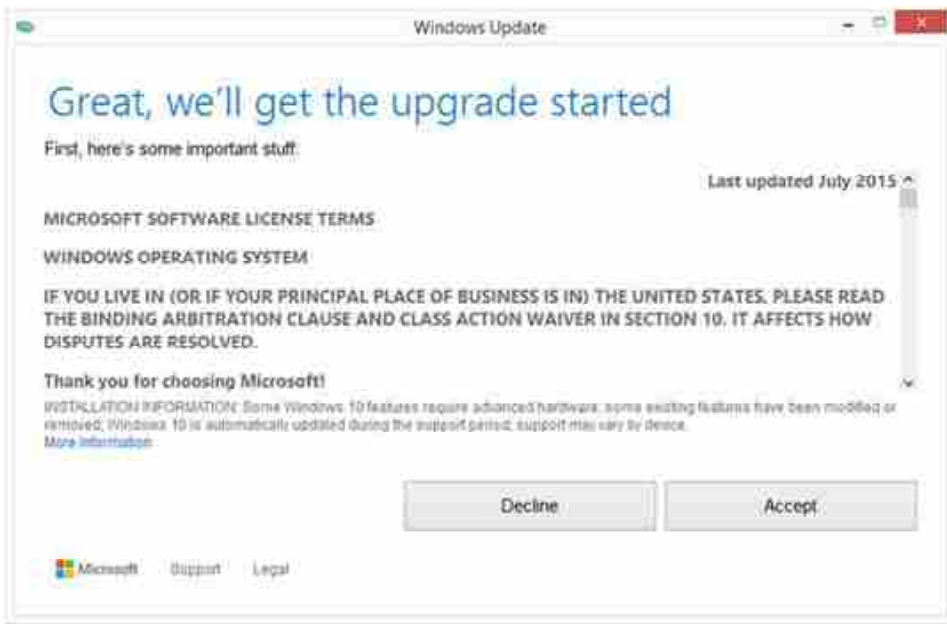

**Step 4 :** After agreeing to the terms, it will ask if you want to install the upgrade at that moment or schedule it for later.

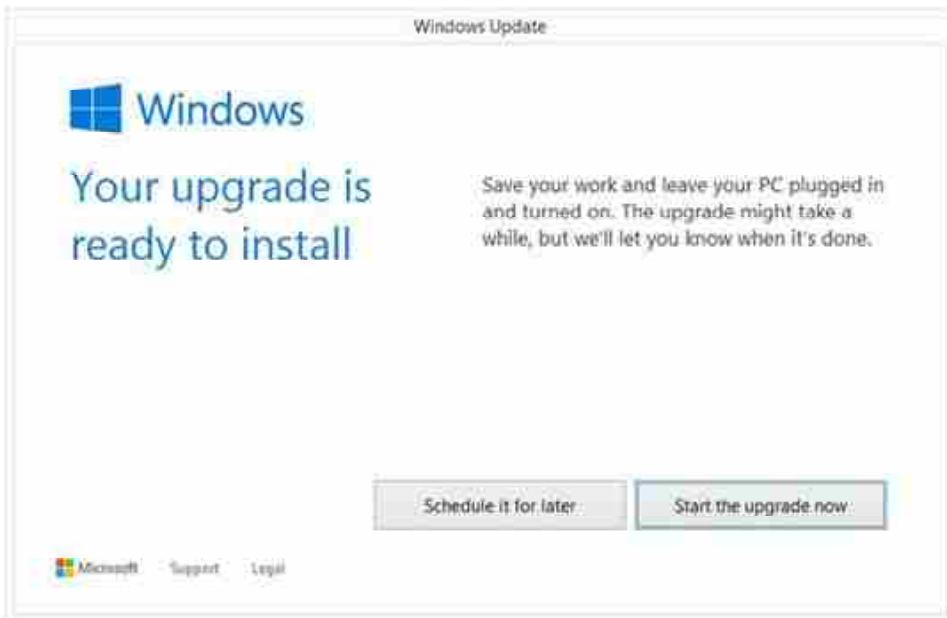

Since the upgrade process can take approximately 2 hours, it will be helpful to schedule it for a time, that will be more suitable to you.

**Step 5 :** Once the upgrade starts, the system will perform a series of tasks, during which you will see the following screen.

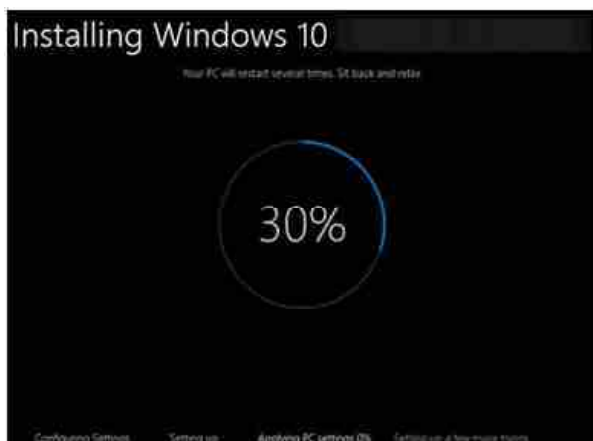

## Operating System and Software Installation

During this time, your computer will reboot a couple of times, so don't worry. The process itself will take you through the steps to complete the upgrade.

**Step 6 :** As the upgrade approaches its end, it will ask you to configure some basic Windows settings. You can choose to use Express settings, which will apply the most common or recommended settings, or you can choose to customize the settings as you please.

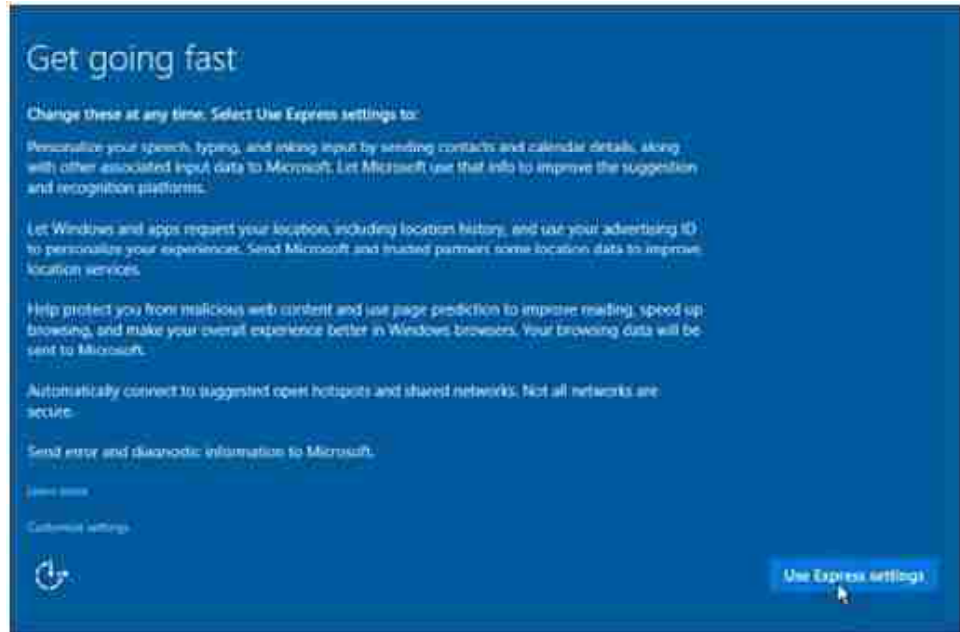

**Step 7 :** After the upgrade finishes, you'll see the Windows welcome screen.

### 16.3 Windows 10 Clean Installation :

**Step-1 :** Make sure your device meets the minimum system requirements

For the latest version of Windows 10, you'll need to have the following :

- **CPU :** 1GHz or faster supported processor (Here is a list of supported CPUs)
- **RAM :** 1GB for Windows 10 32-bit or 2GB for Windows 10 64-bit
- **Storage :** 32GB of space or more
- **GPU :** DirectX 9 compatible or later with WDDM 1.0 driver
- **Display :** 800x600 resolution or greater
- **Internet Connection :** Some versions of Windows 10 require an internet connection during setup.

**Step-2 :** Create installation media

Microsoft has a tool specifically for creating installation media. You can download that tool using this link (<https://www.microsoft.com/en-us/software-download/windows10startfresh>), or by going to this page and selecting "Download tool now" under the section titled "Create Windows 10 installation media."

You'll need a blank USB drive with at least 8GB of space (or a blank DVD) to put the Windows 10 installation files on.

You'll need to run the tool, accept Microsoft's terms, and then select "Create installation media for another PC" when you get to the "What do you want to do ?" page.

You'll select the language and edition of Windows you want as well as whether it will be 32-bit or 62-bit, and then select the type of media you want to use. Installing from a USB drive is easiest, but you can find details on using a DVD and ISO file here. You'll then choose your USB drive from a list of drives, and the tool will download the necessary files and put them on the USB drive.

**Step-3 : Use the installation media**

Insert your installation media into the computer you plan to install Windows 10 on, then access your computer's BIOS or UEFI.

This is the system that allows you to control some aspects of your computer's hardware, and it's built into your motherboard. This step is unique to your specific hardware, so we can't walk you through exactly what to do. But, you should be able to figure out the process for accessing this by checking on your computer or motherboard manufacturer's website.

Generally accessing a computer's BIOS or UEFI involves holding a specific key during the boot process, often Escape, F1, F2, F12, or Delete. So, figure out which key your computer uses, then shut it down. Boot it back up, and hold the necessary key as soon as it starts to boot.

**Step-4 : Change your computer's boot order**

In your computer's BIOS or UEFI, you'll need to find the settings for boot order. This may show up in a section called "Boot" or "Boot order." This decides which devices are used first when the computer starts up.

The computer won't boot into the Windows 10 installation tool unless the drive it's on is higher up in the boot order than the drive holding the computer's current operating system.

You should move the drive (whether it's your USB drive or a DVD drive) to the top of the boot order menu.

You may also need to disable Secure Boot if your computer uses it.

**Step-5 : Save settings and exit BIOS/UEFI**

Your computer should now boot into the Windows 10 installation tool.

**Step-6 : On prompt, press any key to boot from the device.**

**Step-7 : On the "Windows Setup," click the Next button.**





## Operating System and Software Installation

**Step-8** : Click the Install now button.

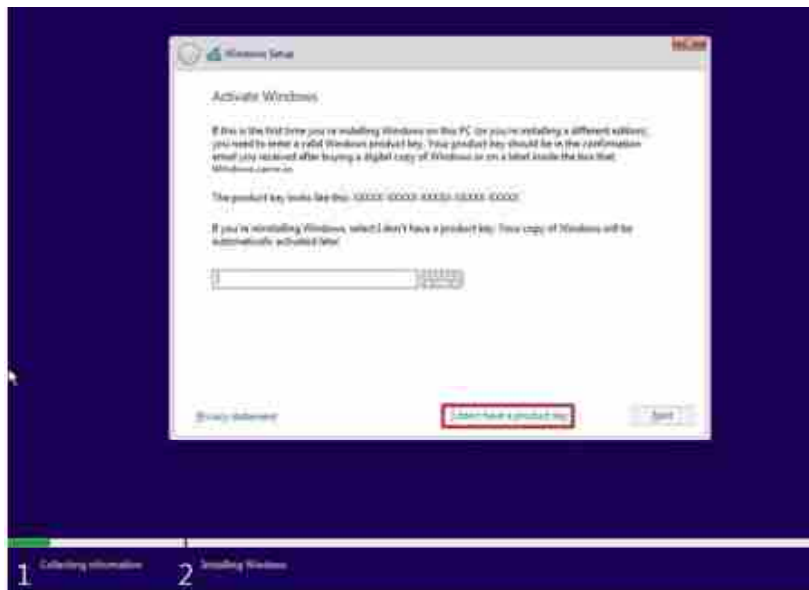

**Step-9** : If you're doing a reinstallation, click the I don't have a product key option to continue (assuming that your device was already activated). Otherwise, in the case that this is your first time installing Windows 10, enter the product key.

**Step-10** : Click the Next button.

**Step-10** : Select the edition of Windows 10 (If applicable).

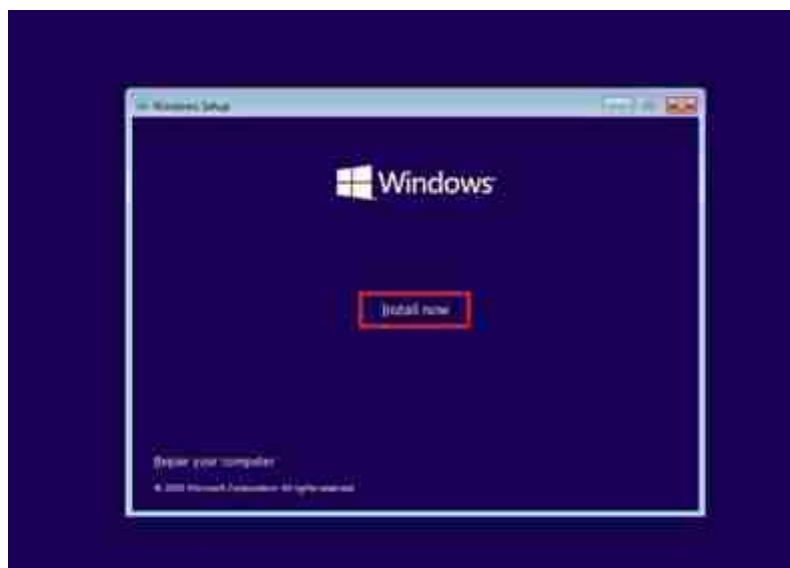

**Step-11** : Click the Next button.

**Step-12** : Select the I accept the license terms option to continue.

**Step-13** : Click the Next button.

**Step-14** : Click the Custom : Install Windows only (Advanced) option to continue with a clean installation.

## Operating System and Application Software Installation

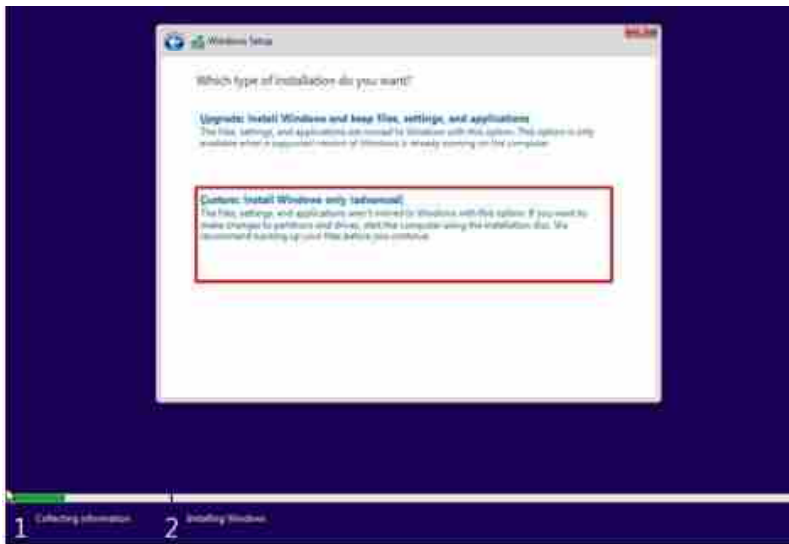

**Step-15 :** Select the partition with the current installation (usually "Drive 0"), and click the Delete button.

**Step-16 :** Click the Yes button.

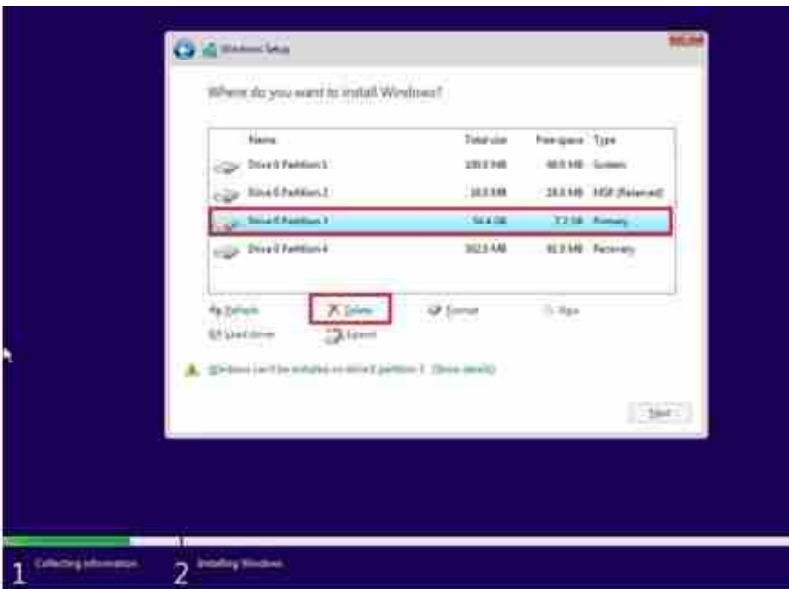

**Step-17 :** Select the empty drive (Drive 0 Unallocated Space).

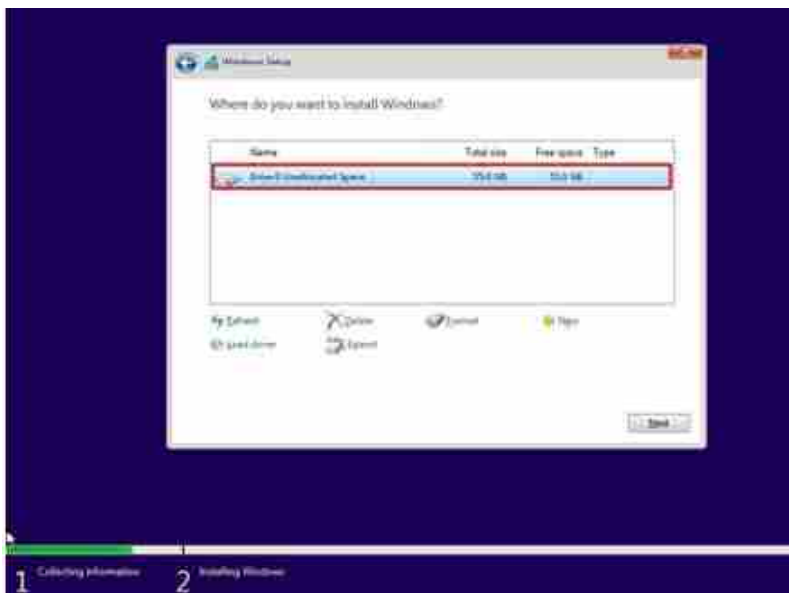

**Step-18 :** Click the Next button.

Once you complete the steps, the setup will install a fresh copy of Windows 10 on the computer.

### **16.4 Windows 10 Out-of-Box Experience :**

After the setup, you have to continue with the out-of-box experience to configure your preferences and create a new account.

This topic follows the out-of-box experience available with the Windows 10 October 2020 Update.

However, depending on the release you are installing, the steps may be slightly different.

To complete the OOBE on Windows 10, use these steps :

1. Select your **Region** option.

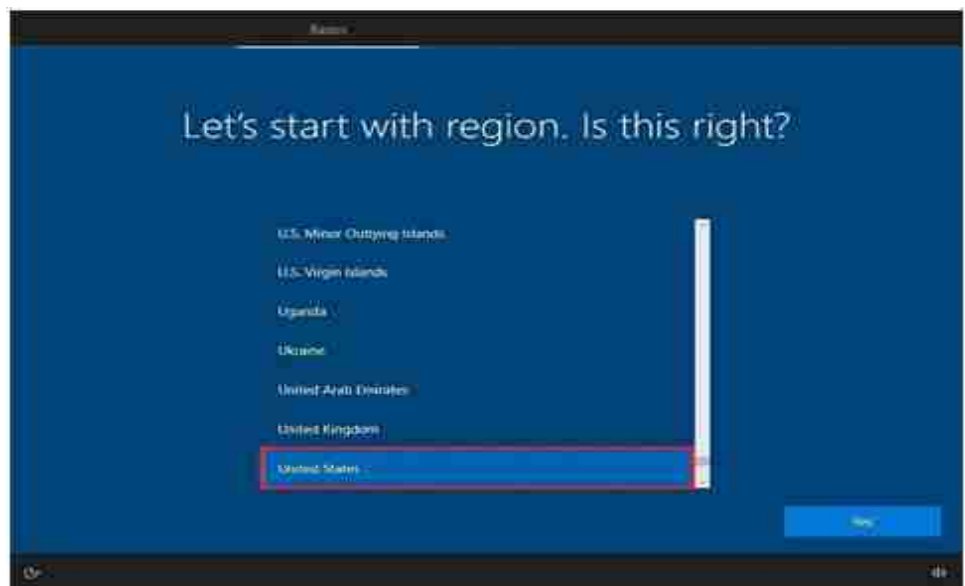

**Source :** Windows Central

2. Click the **Yes** button.
3. **Select your keyboard layout option.**

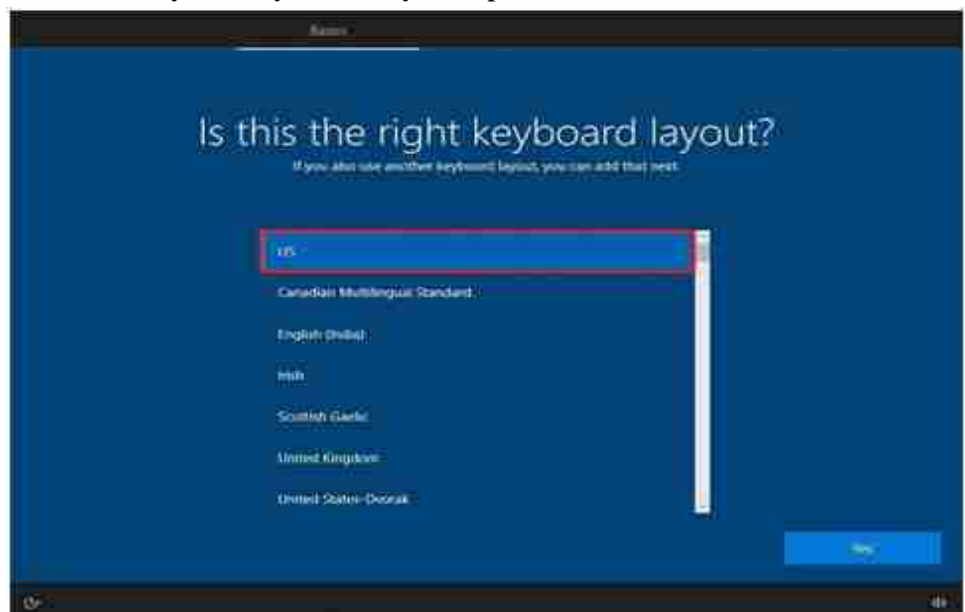

**Source :** Windows Central

4. Click the **Yes** button.
5. Click the **Skip** button (unless you need to add a second keyboard layout).
6. Select the **Set up for personal use** option.

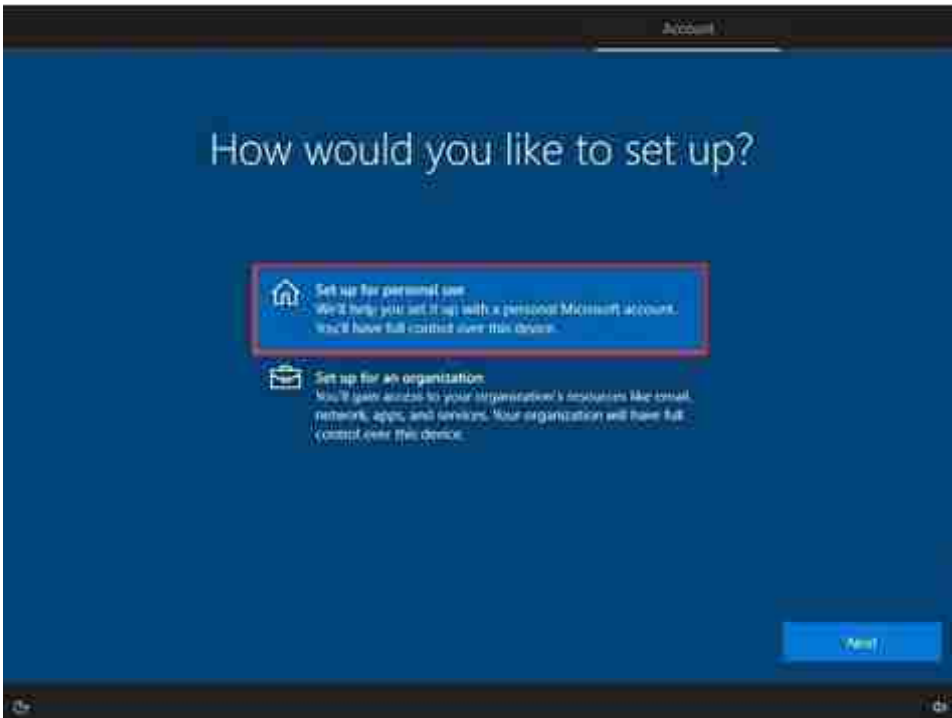

**Source : Windows Central**

7. Click the **Next** button.
8. Confirm your Microsoft account information to create an account.

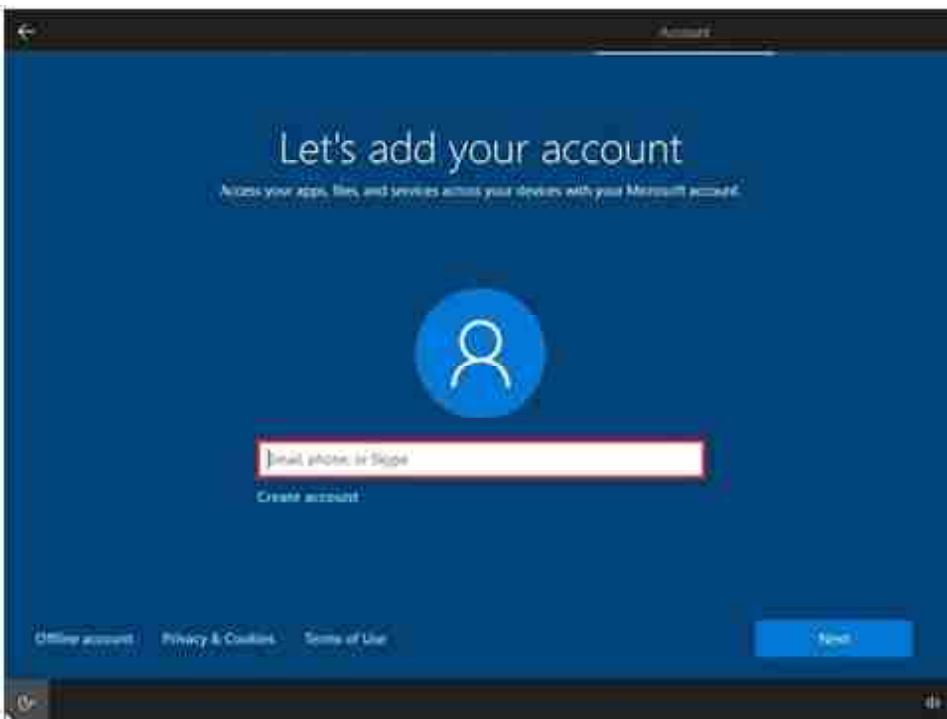

**Source : Windows Central**

**Operating System and Software Installation**

9. Click the **Next** button.
10. Confirm your account password.

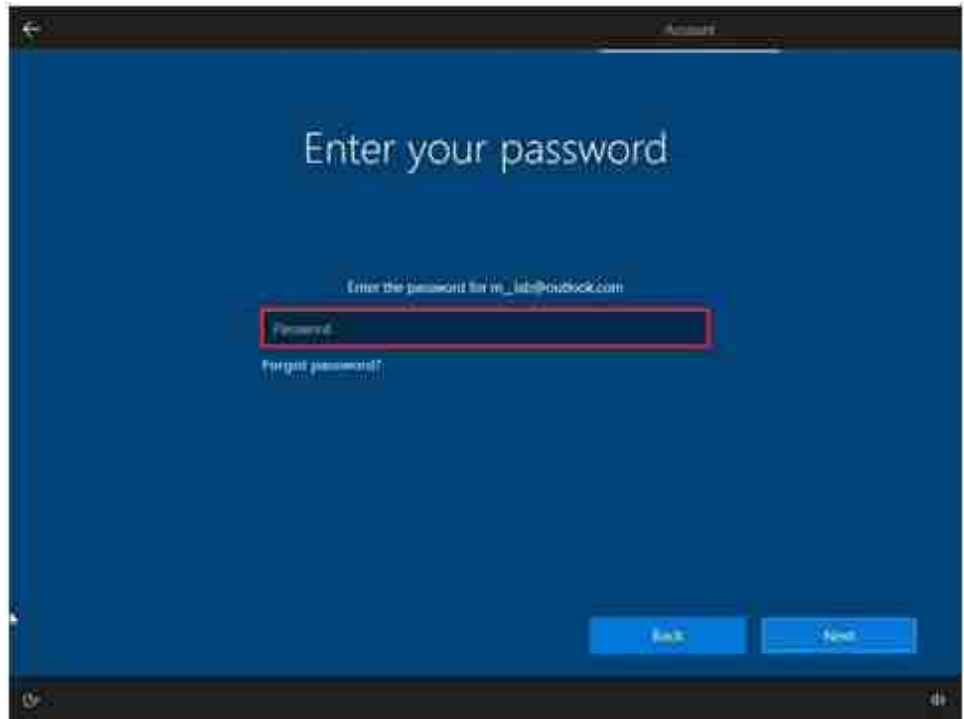

**Source : Windows Central**

11. Click the **Next** button.
12. Click the **Create PIN** button.

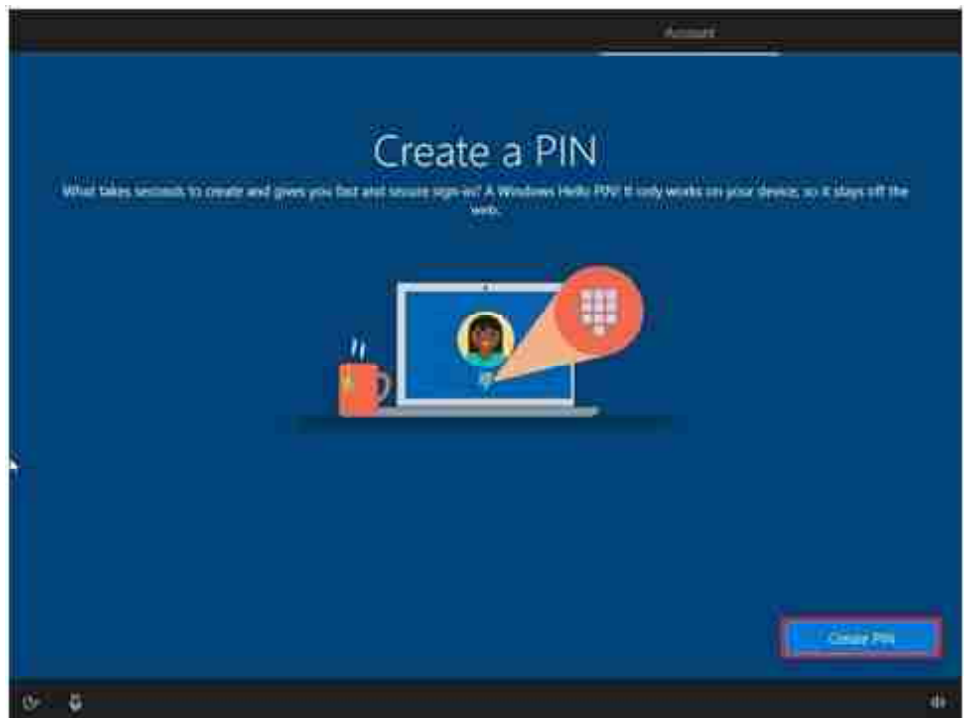

**Source : Windows Central**

13. Create a four-digit Windows Hello PIN.

## Operating System and Application Software Installation

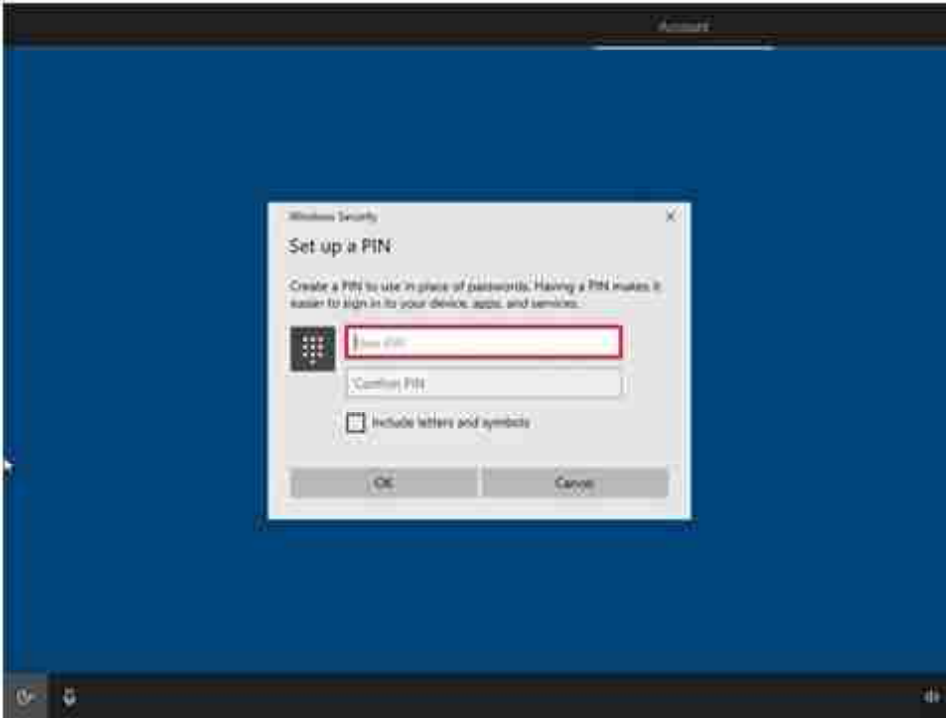

Source : Windows Central

14. Select your privacy settings (and don't forget to scroll down the page to review all the available settings).

15. Click the **Accept** button.



Source : Windows Central

## Operating System and Software Installation

16. Optionally You can provide your phone number and then click the **Send** button to link your phone with your device. If you want to skip this option, click the **Do it later** button in the screen's bottom-left corner.

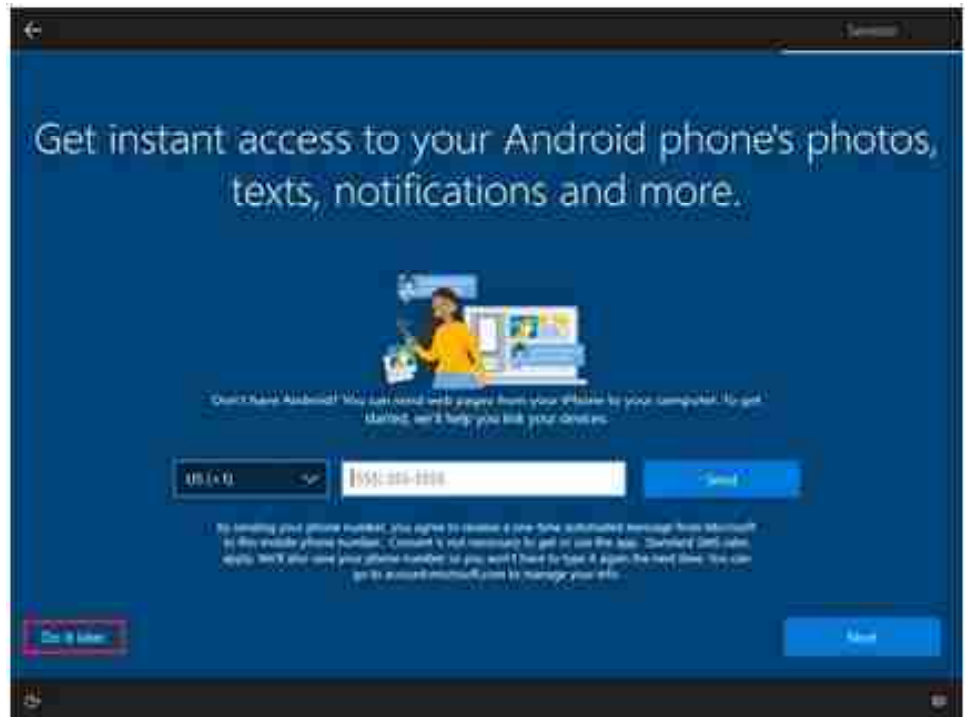

Source : Windows Central

17. Optionally Click the **Next** button to allow OneDrive to backup the Desktop, Documents, and Pictures folders to the cloud. If you use another cloud service or prefer not to upload files to the cloud, click the **Only save files to this PC** option in the screen's bottom-left corner.



Source : Windows Central

18. Click the **No, thanks** button to skip the Microsoft 365 setup (as necessary).



**Source : Windows Central**

- 19. Optionally Check the **Let Cortana respond to "Hey Cortana"** option to use the assistance hands-free.
- 20. Click the **Accept** button to allow Microsoft to collect personal information to make Cortana more personal. If you're not interested in the digital assistant, click the **Not now** button to continue.



**Source : Windows Central**

After you complete the steps, the new settings will apply to the clean installation of Windows 10, and you should be able to see the default desktop experience.



**16.5 Install Microsoft 365 or Office 2019 on a PC :**

Before you begin, make sure your PC or Mac meets the system requirements.

If this is the first time you're installing Office you may have some setup steps to do first. Expand the learn more section below.

However, if you're reinstalling Office, you've already redeemed a product key, or you're installing Office at work or school and know you have a license, then go to the section sign in and install Office on your PC or Mac.

**Sign in to download Office**

1. Go to [www.office.com](http://www.office.com) and if you're not already signed in, select Sign in.
2. Sign in with the account you associated with this version of Office. This account can be a Microsoft account, or work or school account. I forgot the account I use with Office
3. After signing in, follow the steps that match the type of account you signed in with.

**If You signed in with a Microsoft account**

- (a) From the Office home page select Install Office.

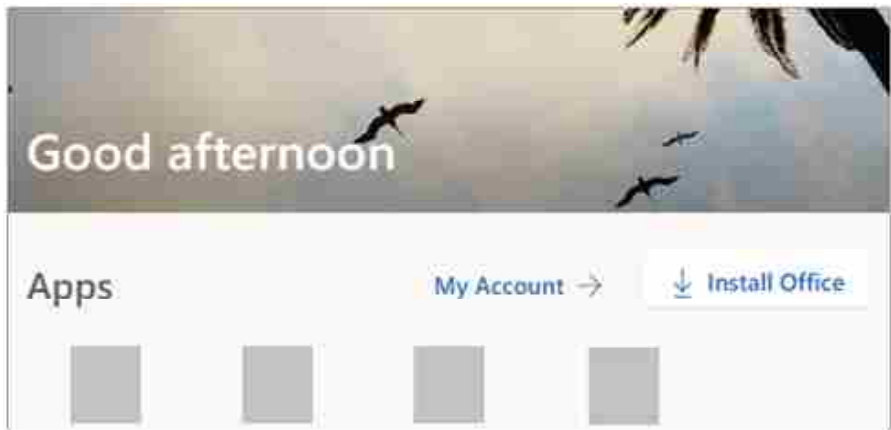

- (b) Select Install (or depending on your version, Install Office>).

**If You signed in with a work or school account**

- (a) From the home page select Install Office (If you set a different start page, go to [aka.ms/office-install](http://aka.ms/office-install).)

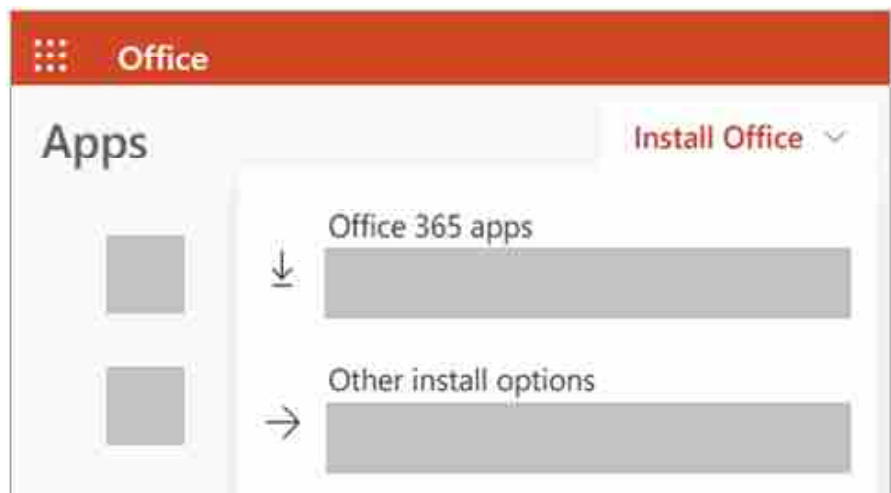

- (b) Select Office 365 apps to begin the installation.

The 64-bit version is installed by default unless Office detects you already have a 32-bit version of Office (or a stand-alone Office app such as Project or Visio) installed. In this case, the 32-bit version of Office will be installed instead.

To change from a 32-bit version to a 64-bit version or vice versa, you need to uninstall Office first (including any stand-alone Office apps you have such as Project or Visio). Once the uninstall is complete, sign in again to [www.office.com](http://www.office.com) and select Other install options, choose the language and version you want (64 or 32-bit), and then select Install

4. This completes the download of Office to your device. To complete the installation, follow the prompts in the "Install Office" section below.

#### **Install Office**

1. Depending on your browser, select **Run** (in Edge or Internet Explorer), **Setup** (in Chrome), or **Save File** (in Firefox).

If you see the User Account Control prompt that says, **Do you want to allow this app to make changes to your device ?** select **Yes**.

**The install begins.**



2. Your install is finished when you see the phrase, **"You're all set! Office is installed now"** and an animation plays to show you where to find Office applications on your computer. Select **Close**.

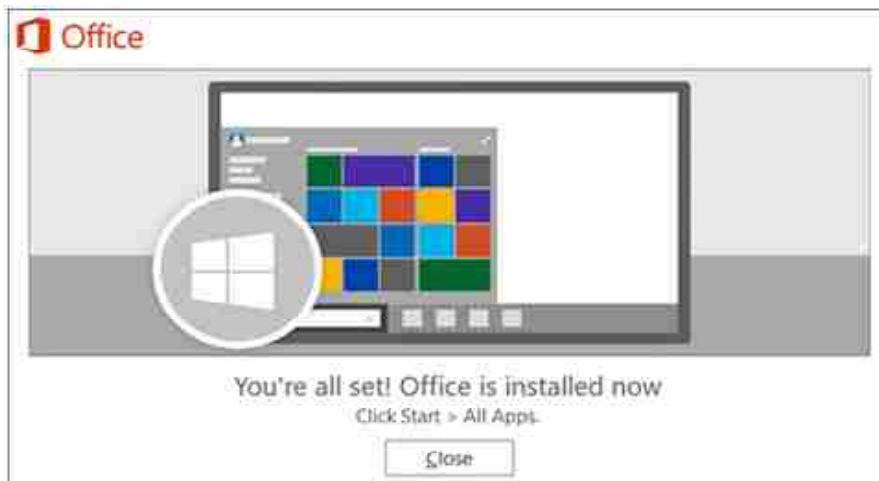

**Activate Office**

1. To open an Office app, select the **Start** button (lower-left corner of your screen) and type the name of an Office app, like **Word**.
2. To open the Office app, select its icon in the search results.
3. When the Office app opens, accept the license agreement. Office is activated and ready to use.

**16.6 Check Your Progress :**

1. Which of the following operating systems is not owned and licensed by a company ?  
(A) Windows (B) Mac (C) Linux (D) Unix
2. Which is the latest version of MS Windows  
(A) Windows 2007 (B) Window 8  
(C) Windows 8.1 (D) Windows 10
3. Which is the latest version of MS Office  
(A) MS office 2007 (B) Ms Office 2013  
(C) Ms Office 2016 (D) MS Office 365

**16.7 Let Us Sum Up :**

In this unit we have learn step by step process to upgrade or clean install window on personal computer. We have also learn how to download, install and activate Microsoft Office 365 or Microsoft Office 2019 on personal computer.

**16.8 Check Your Progress : Possible Answers :**

1. (a),
2. (b),
3. (c)

**16.9 Assignment :**

- Explain step by step process to install Microsoft Windows 10
- Differentiate between upgrade and clean installation of Windows 10
- Explain Activation process for Microsoft Office 365

**16.10 Activity :**

- Create installation media for Window 10

**16.11 Case Study :**

- Differentiate between Window 8.1 and Window 10

**16.12 Further Reading :**

- <https://www.microsoft.com/en-us/software-download/windows10startfresh>
- <https://www.windowcentral.com/how-do-clean-installation-windows-10>
- <https://support.microsoft.com/en-us/office/download-and-install-or-reinstall-microsoft-365-or-office-2019-on-a-pc-or-mac-4414eaaf-0478-48be-9c42-23adc4716658>

## **BLOCK SUMMARY :**

## **Operating System and Application Software Installation**

- Security in a computer system focuses on safeguarding the resources (hardware, software) of a system.
- A system's resource may be damaged by intention or non-intentionally.
- Intruders are people and programs that intentionally damage a system
- Accidental data loss is non-intended system damage as a result of different phenomenon like natural accidents, hardware/software errors etc...
- Trojan horse, logic bomb, spoofing, buffer overflow are some of the attacks from inside the system
- Viruses, worms, mobile codes are attacks from outside the system.
- The system should allow different users to access different resources in a shared way and needs to ensure that each object is accessed correctly and only by those processes that are allowed to do so.
- A computer system needs to protect itself from unwanted and illegitimate access.
- A threat is a potential situation that results in unsecured system.
- The threats are initiated by intruders which can be either active or passive and attack a system through different attacking mechanisms.
- Attacks happen from inside a system or outside a system and can be intentional or non-intentional.
- System uses different mechanisms to protect itself from such attacks including cryptography, user authentications, access control mechanisms and other software methods like use of anti-viruses, etc.
- Cryptography is a science and art of communication where by the communicated information is changed to a code that can't be perceived by any other entity except the communicating ones. It encompasses both encryption and decryption schemes to achieve its objective.
- Encryption is a way used to hide information communicated between a sender and a receiver with an objective of avoiding any harm on the information by illegitimate users.
- A message encrypted on the sender side needs to be reverted back to its original representation with a process of decryption.
- Cryptography can be symmetric or Asymmetric depending on the code generation method it utilizes.
- Authentication is a means by which object's identity is validated for further service provision.
- The system uses several methods of authentication such as authentication by password, question-response, biometrics, physical objects, etc.
- Access control is a way of managing permissions to subjects on objects.
- Three access control model are DAC, MAC, and RBAC each with their own implementation.

<b>BLOCK ASSIGNMENT :</b>
---------------------------

**Short Questions**

- What is security ?
- What is cryptography ?
- What is authentication ?
- How does the buffer overflow attack a system ?
- What are the solution to protect system from worm attacks ?
- What is a Trojan horse ?
- What is inside attack ?
- What is outside attack ?
- What is the difference between inside attack and outside attack ?
- How does a challenge response authentication works ?

**Long Question**

- How does Trojan Horse operate and attack a system ?
- Explain two implementations of MAC model
- Explain the difference among a virus and worm
- What advantages does the RBAC has over the other access control methods ?
- Differentiate DAC model from the MAC model
- Explain the differences between inside attack and outside attack



# DR. BABASAHEB AMBEDKAR OPEN UNIVERSITY

'Jyotirmay' Parisar,  
Sarkhej-Gandhinagar Highway, Chharodi, Ahmedabad-382 481.  
Website : [www.baou.edu.in](http://www.baou.edu.in)